

Operating Manual

ELT Lite



Important safety information



Read this manual before attempting to install the device!

Failure to observe recommendations included in this manual may be dangerous or cause a violation of the law. The manufacturer, Elektroniksystem i Umeå AB will not be held responsible for any loss or damage resulting from not following the instructions of this operating manual.

- The device must not be dismantled or modified in any way.
- The device is not intended to be used as a reference sensor, and Elektroniksystem i Umeå AB will not be held liable for any damage which may result from inaccurate readings.
- The battery should be removed from the device if it is not to be used for an extended period. Otherwise, the battery might leak and damage the device. Never leave a discharged battery in the battery compartment.
- The device must never be subjected to shocks or impacts.
- To clean the device, wipe with a soft moistened cloth. Use another soft, dry cloth to wipe dry. Do not use any detergent or alcohol to clean the device.

Disposal note in accordance with ElektroG and WEEE Directive 2012/19/EU

The device, as well as all the individual parts, must not be disposed of with household waste or industrial waste. You are obliged to dispose of the device at the end of its service life in accordance with the requirements of ElektroG in order to protect the environment and to reduce waste through recycling. For additional information and how to carry out disposal, please contact the certified disposal service providers. The sensors contain a lithium battery, which must be disposed of separately.



Contents

Description.....	5
Main features of ELT Lite	6
Installation.....	7
Installing external sensors	8
External temperature sensor.....	8
Analog input 0 – 3 or 0 – 10 Voltage.....	8
Powered analog input 0 – 10V.....	9
Pulse count (Pull up)	9
Pulse count (Pull down)	10
Pulse count (Pull down) – External pulse.....	11
Pulse count (Pull up) – S0 input.....	11
4 – 20 mA input.....	12
Water leak input.....	12
Meter (Decagon) sensor input	13
Sensor configuration.....	13
NFC Configuration.....	13
Over the air configuration	14
Application parameters.....	14
Sensor behavior.....	15
NFC Read / Write	15
Sensor startup	16
Sampling mode / Periodic measurement	17
External sensors.....	17
Specifications	18
Sensor payload format.....	18

Regulations.....	19
Legal Notices	19
Federal Communication Commission Interference Statement.....	19
Non-modifications Statement	20
Caution	20
Industry Canada Statement.....	20
Declaration of conformity	20

Description

ELT Lite is a universal outdoor device for LoRaWAN® wireless network. It is enclosed in an IP67 box and is designed to be in extreme conditions. ELT Lite can measure analog or digital signals. Use it together with electricity meters, flow meters, analog sensors, moisture sensors and other external sensors. This is a battery-powered device equipped with NFC (Near Field Communication) and can easily be configured from a smartphone.

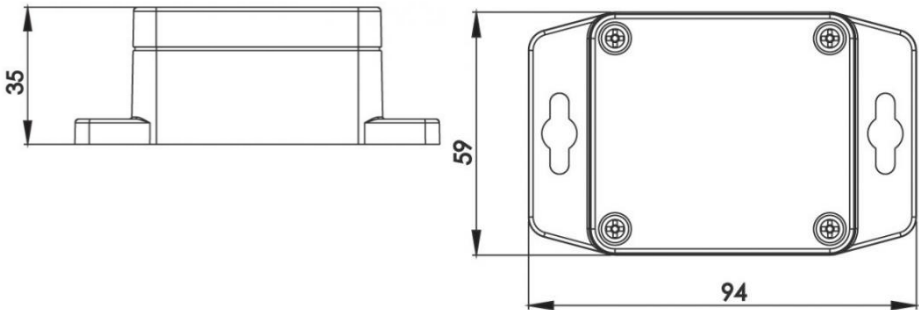

The barcode contains DevEUI and sensor type. This label is located at the back of your device,

Elsys.se ELT-lite

DevEUI: A81758FFFFExxxxxx



elsys.se/lora

S-1933F



Main features of ELT Lite

- Compatible with LoRaWAN® specification 1.0.3
- Analog 0 – 10 V input
- Digital input
- Pulse counter
- Direct connection to various external sensors and equipment
- Easy installation
- Easy configuration
- IP67 Classified
- Battery-powered
- Long-range communication
- Configurable over NFC
- Configurable over the air
- Ten years of battery life*
- Supported channel plans: US902-928, EU863-870, AS923, AU915-928, KR920-923, RU864, IN865 & HK923
- CE Approved and RoHS compliant

**Depending on settings and environmental factors*

Installation

1. Remove the front lid of the sensor by removing the four screws.
2. Install the battery. The ELT Lite requires one AA battery. The battery type is 3.6V Lithium Battery (ER14505).

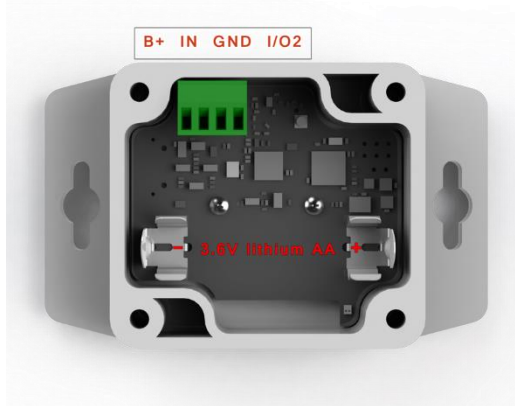

Caution: Using batteries other than the ones provided may result in loss of performance and battery life, and also damage to the device. Dispose of properly, observing environmental protection rules.

3. Connect any eventual external sensors.
4. Close the lid and tighten the screws carefully. Make sure that the cable gland and antenna connection is tightened to prevent ingress of moisture.
5. Mount the device by using the two holes on the sides.

Installing external sensors

External temperature sensor

Configured for 1-wire interface. Connect a DS18B20 compatible sensor. Select "Temperature sensor 1 wire" in the application "Sensor Settings". ELT input is internally pulled up by 2.2kΩ.

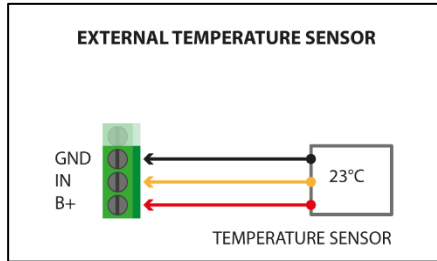

Analog input 0 – 3 or 0 – 10 Voltage

Input signal between input and ground.

Select "Analog input 0-3V" or "Analog input 0 – 10V" in the application "Sensor Settings". ELT input is internally pulled down.

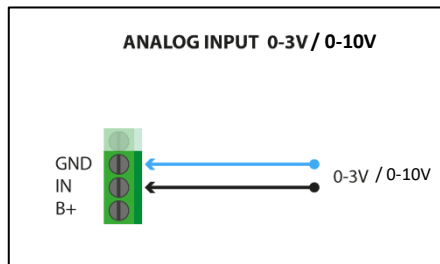

Powered analog input 0 – 10V

Input signal between input and ground. +3V present at B+ pin.

Select “Analog input” in the application “Sensor Settings”. Select “Eternal startup time” and configure ON-time for sensor. External startup time is how long the sensor will be powered before sampling value. ELT input is internally pulled down and the input impedance is 7.4 k Ω

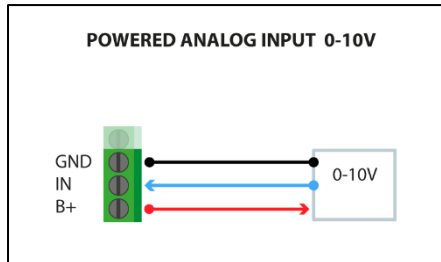

Switch Input (Pull up)

Input signal between input and ground.

Select “Switch (Normally open)” in the application “Sensor Settings”. ELT input is internally pulled up by ~50 k Ω *.

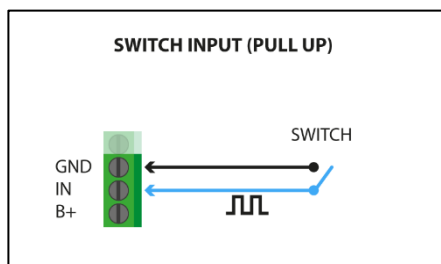

Pulse count (Pull up)

Input signal between input and ground.

Select "Pulse input (pull up)" in the application "Sensor Settings". ELT input is internally pulled up by $\sim 50\text{ k}\Omega^*$.

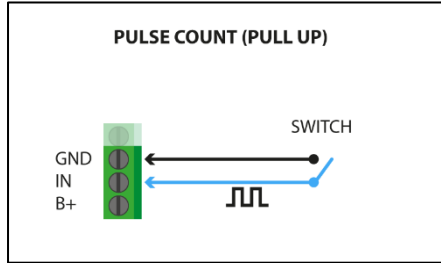

Pulse count (Pull down)

Input signal between input and B+.

Select "External startup time" in the application "Sensor Settings" and configure ON-time for always on that is $>1000000\text{ms}$.

Select "Pulse input (pull down)". ELT input is internally pulled down by $\sim 50\text{ k}\Omega^*$.

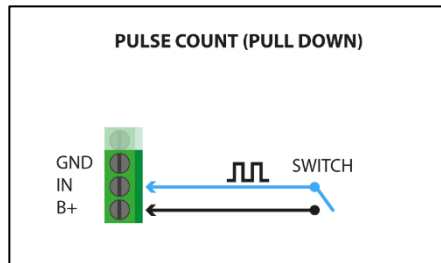

Pulse count (Pull down) – External pulse

Input signal between input and GND. Pulse signal from 3 to 12 voltage.

Select “Pulse input (pull down)” in the application “Sensor Settings”. ELT input is internally pulled down by $\sim 50\text{ k}\Omega^*$.

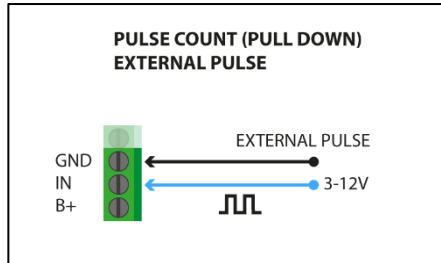

Pulse count (Pull up) – SO input

SO signal between input and ground.

Select “Pulse input (pull up)” in the application “Sensor Settings”. ELT input is internally pulled up by $\sim 50\text{ k}\Omega^*$.

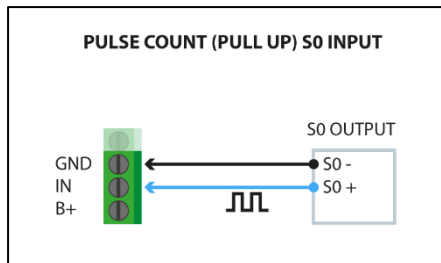

4 – 20 mA input

Select "Analog input" in the application "Sensor Settings". Connect resistor parallel to the input. Value of R can be calculated as $U = R \cdot I$. For full range, use 500Ω resistor. (20mA will then read as 10V).

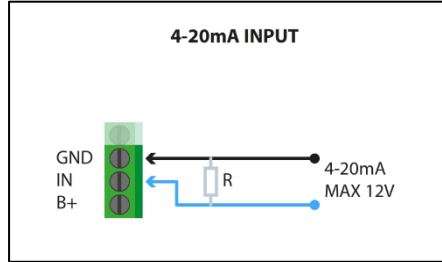

Water leak input

Connect water leak cable, sensor, or open ends to B+ and IN.

Select "Water leak" in the application "Sensor Settings". Range 0-255 depending on conductivity.

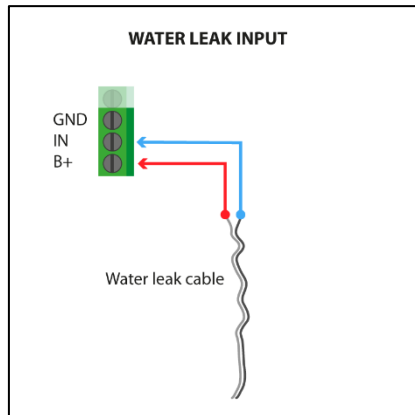

Meter (Decagon) sensor input

Connect the Meter (Decagon) sensor 10HS, EC-5 or ECH20 5TE according to the diagram. Try to use a short cable. Select "Meter (Decagon)" in application "Sensor Settings" or "Meter (Decagon) ECH20 5TE" if you have connected ECH20 5TE.

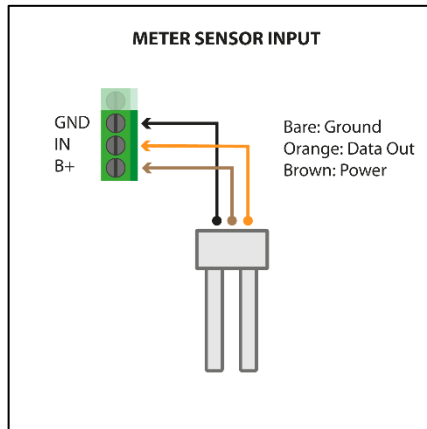

Sensor configuration

All sensor settings can be configured via a smartphone application with NFC (Near Field Communication) or over the air via the network server and downlink data to the sensor. The sampling rate, spreading factor, encryption keys, port, and modes can be changed. All sensor settings can be locked from the server or NFC to make end-users unable to read or change settings on the sensor.

NFC Configuration

1. Download ELSYS "Sensor Settings" application from Google Play or App Store (from iOS 13) and install it on a smartphone or tablet. The device must support NFC.
2. Enable NFC on the device and start the application.

3. Place your device on top of the NFC antenna on the sensor.

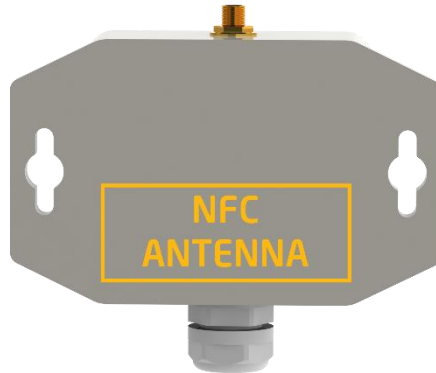

4. Remove the device. Current settings will be displayed in the application.
5. Use the application to change any settings if needed.
6. Quickly tap the device on top of the NFC antenna to give the new settings to the sensor. Make sure that the application confirms your new settings.
7. Wait for the sensor to reboot (5 sec), indicated by the LED flashing. Sensor settings have been updated.

See the section “Help” in the application for more information.

Over the air configuration

All settings may be configured over the air via your LoRaWAN® infrastructure. Please visit the support section on our webpage for more information regarding downlink protocol.

Application parameters

All parameters for the “Sensor settings” application can be found in our settings document. Please visit the support section on our webpage for more information.

Sensor behavior

NFC Read / Write

1. When reading or writing NFC configuration data to the sensor, it starts a timer and delays its action 5 seconds.
2. After the delay, the sensor determines if the NFC data has changed or not. If the data has changed, the sensor reboots and starts from power-up.
3. Write your settings in the application and then locate the NFC antenna of the phone and sensor. Keep the two devices close and don't move them to get the best connectivity as possible when writing or reading data to the sensor. Bad connection can be caused by long distance, wrong location, or rapid movement.
4. When you have written data to the sensor, let the sensor reboot and restart before trying to write again.

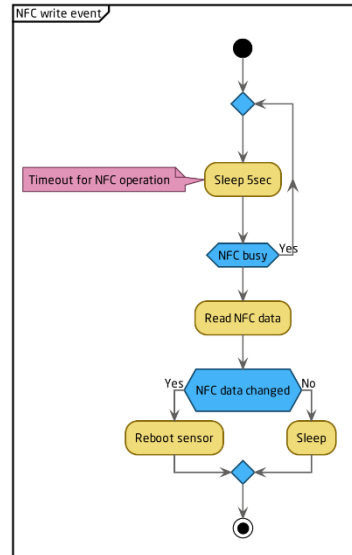

You should always validate your settings by reading the NFC data after the sensor has restarted.

Sensor startup

1. When the sensor starts up, it loads configuration from the internal memory and merges it with user configuration.
2. When the configuration is done, the sensor writes the new configuration to the NFC chip. The sensor always writes new configurations to the NFC chip when something changes in the sensor or if NFC data is corrupted by an NFC writer or phone. The sensor always writes the new configuration to NFC chip at startup.
3. When the configuration is done, the sensor tries to join the network if OTAA (Over the Air Activation) is enabled.
4. The sensor LED flashes orange when it tries to join a network. It will try to join every 10 seconds initially. This interval will increase to save battery, at most up to one time per hour.
5. After successful connection to a network, the sensor sends a settings packet and enters sampling mode.

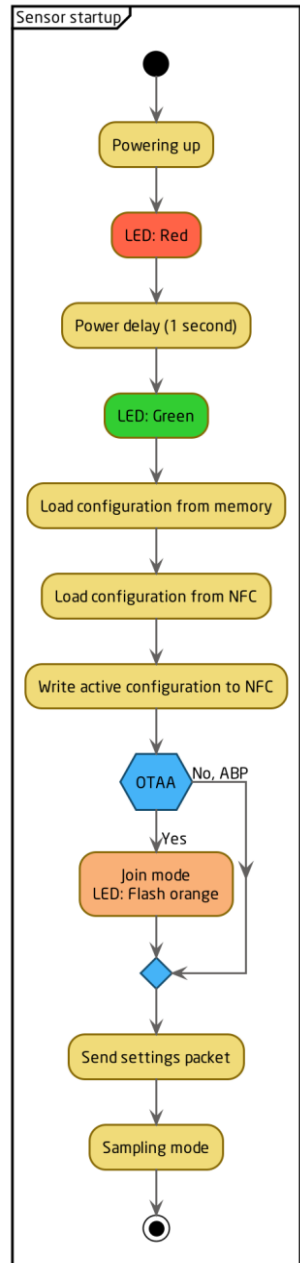

Sampling mode / Periodic measurement

The sensor makes periodic measurements according to the user configurations.

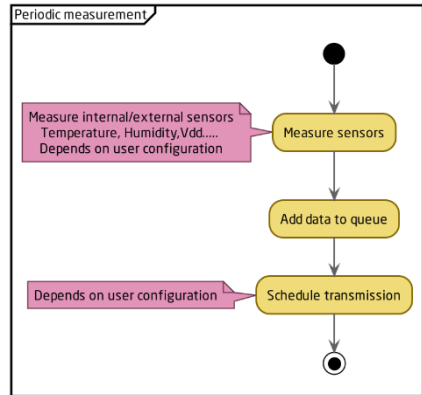

External sensors

The sensor makes periodic measurements according to the user configurations.

External sensors may have additional startup time. Configure the "External startup time" according to this.

For best performance, use a cable as short as possible to your external sensor.

Be careful when configuring the external startup time for your external sensors. If external startup time is set to > 1000000 ms, the external sensor output will be constantly on. This will affect the battery life.

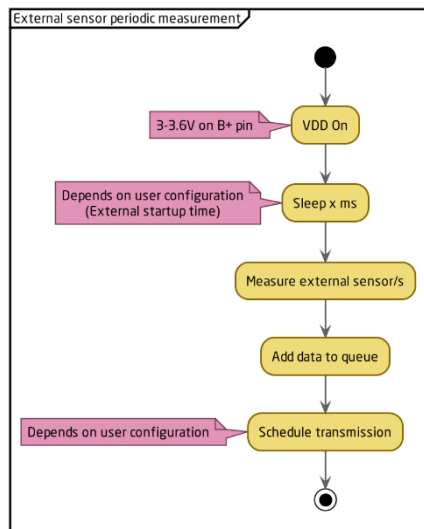

Schedule Transmission

The sensor transmits the data according to the user configurations.

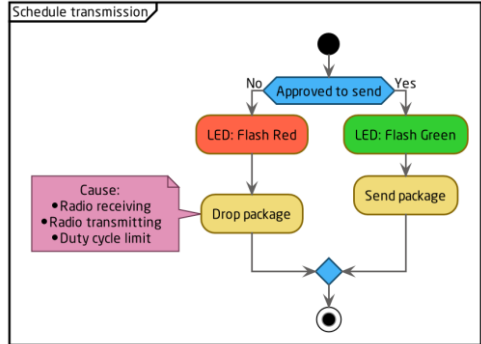

Specifications

Sensor payload format

The device uses the standard ELSYS payload format. Please see the specified document on our webpage.

Power supply:	3.6V DC
Battery type:	AA 14505 (Li-SOCl ₂)
EU directives compliance:	RoHS 2011/65/EU WEEE 2012/19/EU
Radio protocol:	LoRaWAN®
Radio frequency band:	US902-928, EU863-870, AS923, AU915-928, KR920-923, RU864, IN865 & HK923
Range:	8 km*
Operating conditions	-40 °C – 60 °C -40 °C – 85 °C (External power supply) 0 – 100 % RH
Dimensions	94 x 59 x 35 mm
Battery life	Up to 10 years**

*Measured with settings: SF10, 868 Mhz. The range can be greater or less, depending on terrain and building structure.

**Depending on settings and environmental factors.

Regulations

Legal Notices

All information, including, but not limited to, information regarding the features, functionality, and/or other product specification, are subject to change without notice. Elektroniksystem i Umeå AB reserves all rights to revise or update its products, software, or documentation without any obligation to notify any individual or entity. ELSYS and ELSYS logo are trademarks of Elektroniksystem i Umeå AB. All other brands and product names referred to herein are trademarks of their respective holders.

Federal Communication Commission Interference Statement

This equipment has been tested and found to comply with the limits for a Class B digital device, according to Part 15 of the FCC Rules. These limits are designed to provide reasonable protection against harmful interference in a residential installation. This equipment generates, uses and can radiate radio frequency energy and, if not installed and used in accordance with the instructions, may cause harmful interference to radio communications. However, there is no guarantee that interference will not occur in a particular installation. If this equipment does cause harmful interference to radio or television reception, which can be determined by turning the equipment off and on, the user is encouraged to try to correct the interference by one of the following measures:

- Reorient or relocate the receiving antenna.
- Increase the separation between the equipment and receiver.
- Connect the equipment into an outlet on a circuit different from that to which the receiver is connected.
- Consult the dealer or an experienced radio/TV technician for help.

Non-modifications Statement

Any changes or modifications not expressly approved by the party responsible for compliance could void the user's authority to operate this equipment.

Caution

This device complies with Part 15 of the FCC Rules. Operation is subject to the following two conditions:

(1) This device may not cause harmful interference, and (2) this device must accept any interference received, including interference that may cause undesired operation.

This device and its antenna(s) must not be co-located or operating in conjunction with any other antenna or transmitter except in accordance with FCC multi-transmitter product procedures.

Industry Canada Statement

This device complies with Industry Canada license-exempt RSS standard(s). Operation is subject to the following two conditions:

(1) this device may not cause interference, and

(2) this device must accept any interference, including interference that may cause undesired operation of the device.

Declaration of conformity

Hereby, Elektroniksystem i Umeå AB declares that ELT Lite complies with the essential requirements and other relevant provisions of Directive 1999/5/EC.