



- Cost effective 2G/3G/4G signal booster
- Easy installation
- Wall mount or mast mount

The B4BE range has been designed to provide cost effective coverage booster antennas for 2G/3G/4G devices. The antennas are designed for wall or mast mounting and are weather proof allowing the device to reap the benefits of an antenna mounted in an elevated or external location where the signal is strongest.

The omni-directional radiation pattern allows the antenna to be quickly installed while the global Cellular/GSM/LTE coverage provided by the antenna allows it to be utilised for 2G/3G and 4G applications the world over.

These antennas provide an ideal solution for modem devices whether for domestic or business wireless data or for machine to machine applications and connected devices.

Technical Drawing

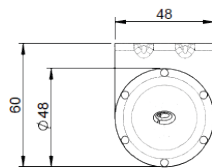

FREQUENCIES.
698 - 960 MHz
1710 - 2700 MHz

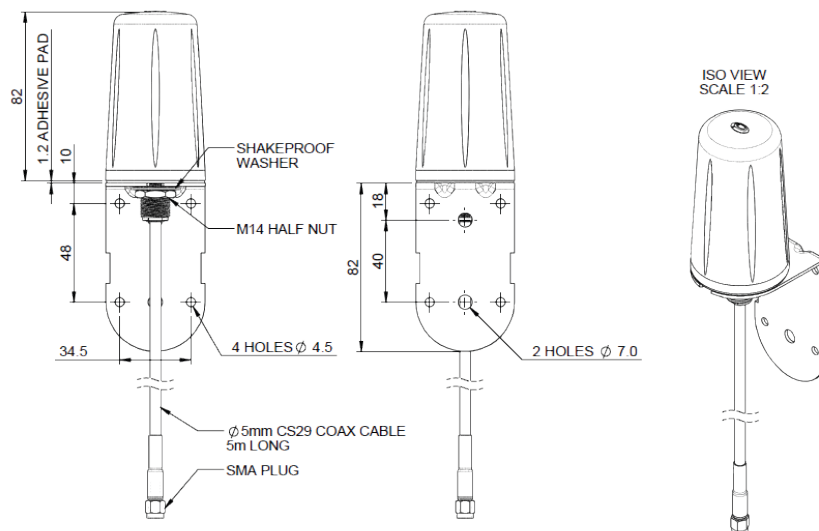

H Plane Plot (700 MHz)

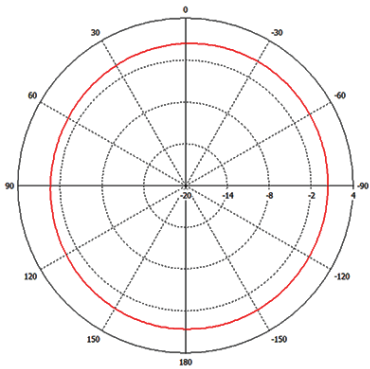

E Plane Plot (700MHz)

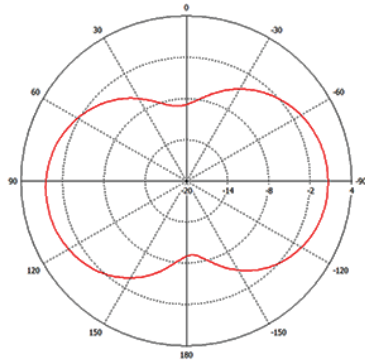

H Plane Plot (800MHz)

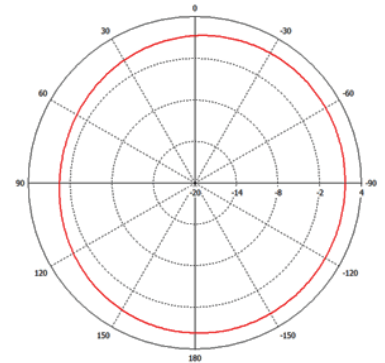

E Plane Plot (800MHz)

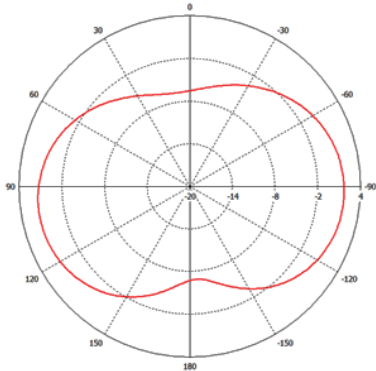

H Plane Plot (900MHz)

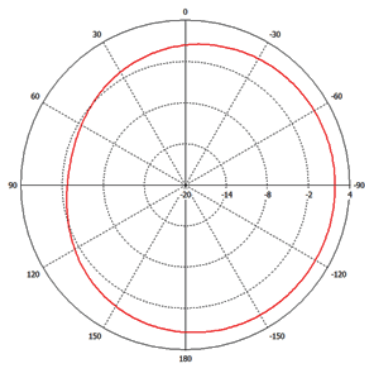

E Plane Plot (900MHz)

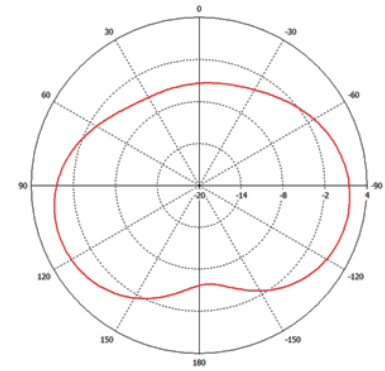

H Plane Plot (1800 MHz)

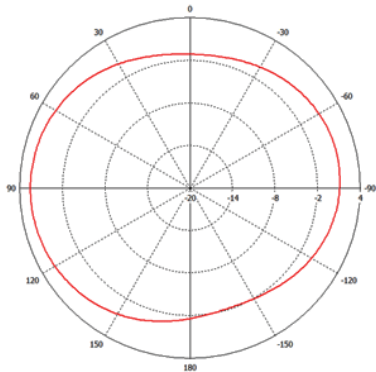

E Plane Plot (1800MHz)

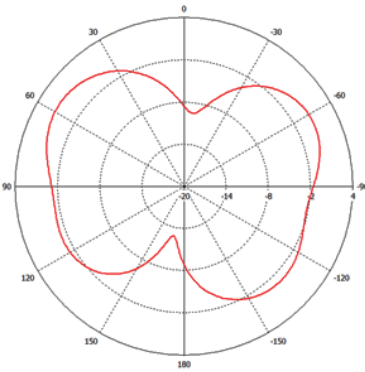

H Plane Plot (2100MHz)

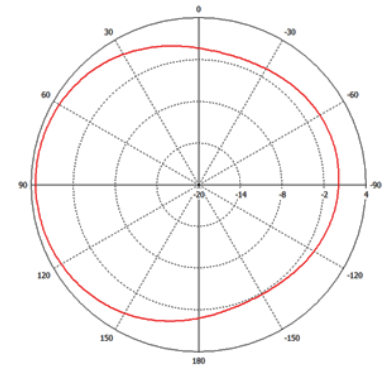

E Plane Plot (2100 MHz)

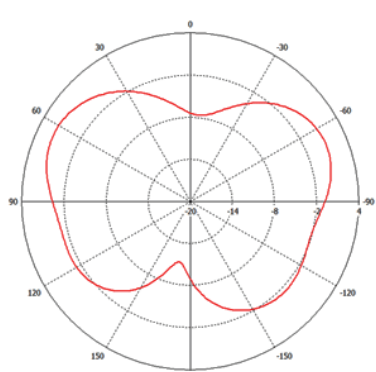

H Plane Plot (2600MHz)

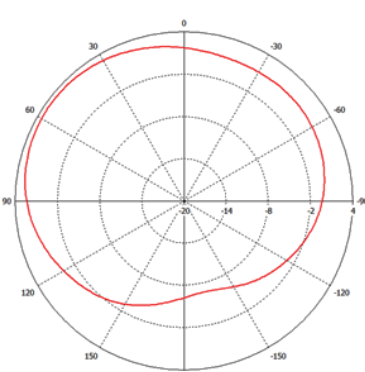

E Plane Plot (2600MHz)

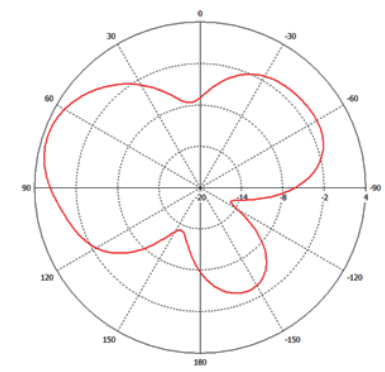

Typical VSWR (B4BE-7-27-5SP)

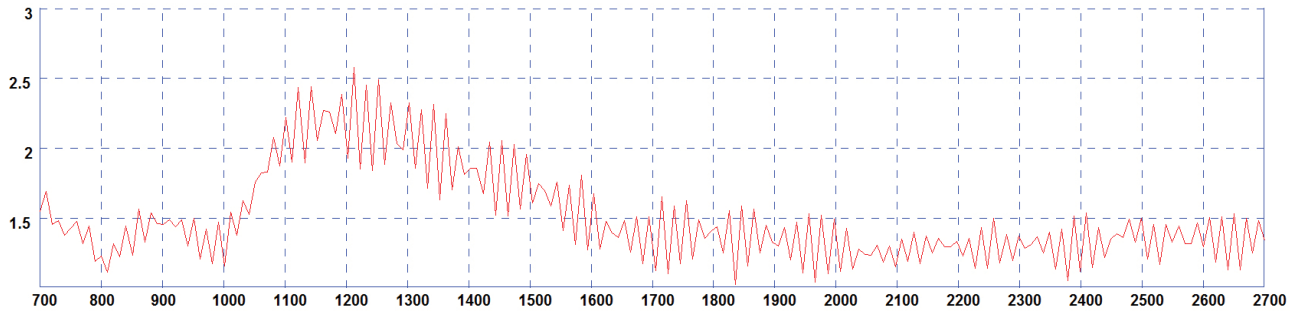

*Measured with 5m of CS29 cable

Part No.		B4BE-7-27-5SP	B4BE-7-27-05SP
Electrical Data			
Frequency Range (MHz)		698-960, 1710-2700	
Operational Band		LTE 700 , AMPS / GSM850, GSM900, GSM1800, PCS1900, 3G UMTS, 2.4GHz WIFI, 2.6GHz LTE	
VSWR		< 2.5:1	
Peak Gain:	698-960MHz	2dBi	
Isotropic	1710-2700MHz	4dBi	
Radiated Efficiency*		> 70%	
Pattern		Omni-directional	
Polarisation		Vertical	
Impedance		50Ω	
Max Input Power (W)		60	
Mechanical Data			
Dimensions	Height Mounted	164 (6.46")	
(mm)	Diameter	48 (1.89")	
Operating Temp (°C)		-40°/+80°C (-40°/176°F)	
Material		ABS., Aluminium and Galvanised Steel	
Colour		Black & Natural	
Mounting Data			
Fixing		Wall mount or Mast mount	
Mounting	Height	82 (3.2")	
Bracket	Recommended Screw	4 (0.16")	
(mm)	Fixings		
Cable Data			
Type		CS29	
Diameter (mm)		5 (1.9")	
Length (m)		5 (16'4")	0.5 (19.6")
Termination		SMA Plug	SMA Plug

*Excluding cable loss



m2m Germany GmbH
 Am Kappengraben 18
 D-61273 Wehrheim
 Tel.: +49 (0)6081 58738 60
 E-Mail: info@m2mgermany.de
 www.m2mgermany.de