

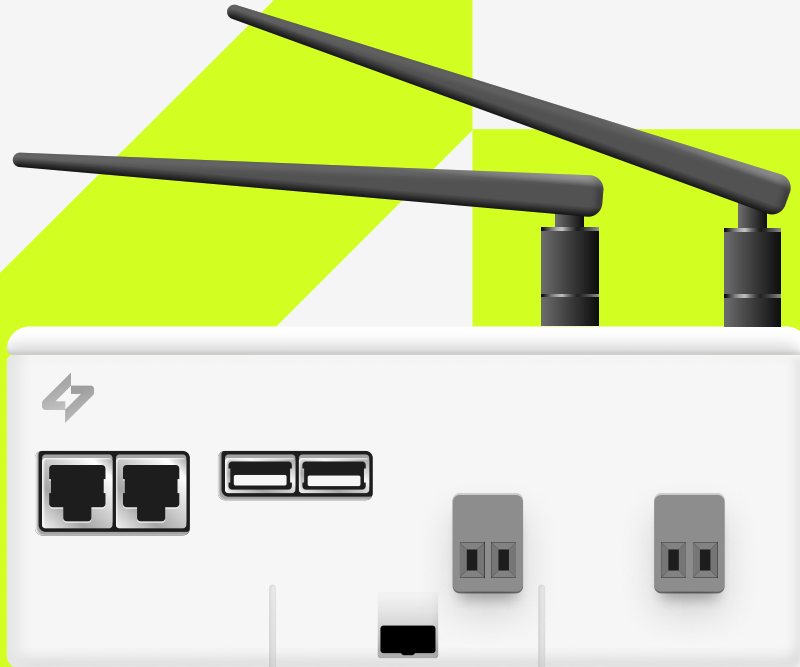

Made in france



● Simplify BMS

# Installation Guide

Box



# Table of contents

<b>Part 1 - Safety Rules</b>	<b>3</b>
EN 60730-1 Power supply considerations:	4
Markings:	5
<b>Part 2 - The Wattsense box - Technical Datasheet</b>	<b>9</b>
Power supply	9
Hardware	9
Interfaces	10
Drivers	10
Software	11
Security	11
<b>Part 3 - Installation Guide</b>	<b>13</b>
Provided material	13
Required material	13
Optional hardware depending on the type of connection	14
Computer access to the Wattsense console	14
<b>The power supply of the box</b>	<b>15</b>
<b>GSM Antenna</b>	<b>19</b>
<b>Antenna Position (USA)</b>	<b>20</b>
<b>To connect the box to the BMS</b>	<b>21</b>
<b>In case of IP network (Except LON)</b>	<b>22</b>
In case of LON IP-852 network	24
<b>To connect the box directly to the technical equipment in the absence of a BMS</b>	<b>26</b>
The equipment communicates in Modbus IP	27
The equipment communicates in Modbus RTU (RS485)	30
The equipment communicates in BACnet IP	35
The equipment communicates in LON IP-852	39
The equipment communicates in LPB	41
The equipment communicates in KNX	42
The equipment communicates in M-BUS	43
To connect the box to LoRaWAN sensors	43
<b>Support</b>	<b>45</b>



# Part 1 - Safety Rules:

**Incorrect wiring of this product may damage it and cause other hazards.  
The product must be installed by a qualified professional.**

Make sure the product has been wired correctly before turning on the power.

Before wiring, removing, or mounting the product, be sure to turn off the power. Failure to do so may result in electric shock.

Do not touch electrically connected parts, such as power terminals. Doing so may result in electric shock.

Do not disassemble the product. Doing so may result in electric shock or malfunction. Use the product within the operating ranges recommended in the specifications (temperature, humidity, voltage, shock, mounting direction, atmosphere, etc.) Failure to do so may result in fire or malfunction.

Tighten the electrical wires on the connector. Insufficient tightening of the wires on the terminal may cause a fire.

Disconnect the power supply before installation or maintenance to avoid electric shock or property damage.

Use only copper conductors. Make all connections in accordance with local, state, and national electrical codes.

To reduce the risk of fire or electric shock, install the equipment in a controlled environment relatively free of contaminants.

This equipment is intended for use as a monitoring and control device only. To avoid loss of data or damage to the equipment, do not use it for any other purpose.

The cover or front panel of the device should not be removed. No configuration or maintenance action of the components (e.g. jumpers or battery) by the user requires the removal of the cover; all elements are accessible as connectors on the top, bottom, and side of the device.

The device must be mounted on a DIN rail in a cabinet or in an electrical box.

When the device is mounted inside an enclosure, make sure the enclosure is designed to maintain the required operating temperature range (allowing for 24 watts of dissipation by the controller). This is especially important if it is mounted inside an enclosure with other heat-producing equipment.

This device is intended for indoor use only.

Do not install the device in an area:

- Where there is excessive moisture, corrosive fumes, or explosive vapors,
- Where vibration or shock is likely to occur,
- Subject to electrical noise, e.g. near large electrical contractors, electrical machinery, welding equipment, etc.

This equipment is not suitable for use in areas where children may be present.

The device is not compatible with a Power-Over-Ethernet (POE) network. Connecting it to a network segment carrying power may cause a failure. In this case, you must disconnect the device from the POE network segment, turn it off and on again.

To avoid any risk of injury caused by a fall, the device should not be installed more than 2 meters from the ground.

## EN 60730-1 Power supply considerations:

- Electrical safety in building automation and control systems relies primarily on the use of extra-low voltage, strictly separated from the mains voltage. This low voltage is either SELV or PELV, according to EN 60730-1.
- Protection against electric shocks is ensured by the following measures:
  - Voltage limitation (low voltage supply DC 24V DC +/-10%, SELV or PELV),
  - Protective separation of the SELV system from all circuits other than SELV and PELV,
  - Simple separation of the SELV system from other SELV systems, PELV systems and the ground.
- Field devices such as sensors, status contractors, or actuators connected to the low voltage inputs and outputs of the I/O modules must comply with SELV or PELV requirements. Interfaces to field devices and other systems must also comply with SELV or PELV requirements.
- When power for SELV or PELV circuits is obtained from higher voltage power systems, it shall be provided by a safety transformer or converter designed for continuous operation to power the SELV or PELV circuits.

# ● Markings:



## Disposal and recycling

Electrical and electronic equipment may not be disposed of with household waste. This also applies to products that do not carry this logo. Electrical and electronic equipment contain materials and substances that can harm the environment and human health. At the end of their life, electrical and electronic equipment must therefore be disposed of in an appropriate way. The European WEEE Directive 2012/19/EU applies throughout the European Union. The directives and laws that transpose it into national law may vary from country to country. Environmentally sound disposal is good for your health and protects the environment from harmful substances in electrical and electronic equipment.

- Observe national and local regulations regarding the disposal of electrical and electronic equipment.
- Erase all data stored on electrical and electronic equipment.
- Drop off or send your electrical and electronic equipment to your local specialized collection point

This symbol is only valid in the European Union please contact your local authorities or dealer and ask for the correct method of disposal



## CE Marking

Wattsense declares that this device is manufactured in accordance with the technical specifications of the product and is in compliance in all respects with the relevant standards and regulations



## FCC-IC Compliance Statement

FCC ID : 2A2KQ-WSGW1

This equipment has been tested and found to comply with the limits for a Class B digital device, pursuant to part 15 of the FCC Rules. These limits are designed to provide reasonable protection against harmful interference in a residential installation. This equipment generates, uses and can radiate radio frequency energy and, if not installed and used in accordance with the instruction, may cause harmful interference to radio communications. However, there is no guarantee that interference will not occur in a particular installation. If this equipment does cause harmful interference to radio or television reception which can be determined by turning the equipment off and on, the user is encouraged to try to correct interference by one or more of the following measures

- Reorient or relocate the receiving antenna.
- Increase the separation between the equipment and receiver.
- Connect the equipment into an outlet on circuit different from that to which the receiver is connected.
- Consult the dealer or an experienced radio/TV technician for help.



**WARNING : This product is only to be installed by qualified personnel.**

### Cellular RF

This device contains a cellular RF module with FCC ID : 2AJYU-8PYA004

This device contains a cellular RF module with IC : 23761-8PYA005

FCC Caution:

- 1 Exposure to Radio Frequency Radiation. This equipment must be installed and operated in accordance with provided instructions and the antenna(s) used for this transmitter must be installed to provide a separation distance of at least 20 cm from all persons and must not be collocated or operating in conjunction with any other antenna or transmitter. End-users and installers must be provided with antenna installation instructions and transmitter operating conditions for satisfying RF exposure compliance.
- 2 Any changes or modifications not expressly approved by the grantee of this device could void the user's authority to operate the equipment.
- 3 This transmitter must not be co-located or operating in conjunction with any other antenna or transmitter.
- 4 Changes or modifications to this unit not expressly approved by the party responsible for compliance could void the user authority to operate the equipment.

The cellular antenna delivered by Wattsense meets the FCC-IC regulations. If the installer makes the choice to use another antenna, it must follow the specifications listed below for the device used to comply with FCC/IC regulations limiting both maximum RF output power and human exposure to RF radiation.

- 1 Whip antenna type
- 2 50 Ohm typical impedance
- 3 Maximum antenna gain

Frequency Band	Antenna Gain (dBi)
GSM850	-1
GSM1900	6
GPRS850 4TS	-1
GPRS1900 4TS	6
WCDMA Band2	10
WCDMA Band4	9
WCDMA Band5	7
LTE Band2	10
LTE Band4	11
LTE Band5	7
LTE Band7	10
LTE Band12	6
LTE Band13	6
LTE Band25	10
LTE Band26	8
LTE Band41	9
LTE Band66	9



## LoRaWAN RF

This device contains a cellular RF module with FCC ID : 2AJYU-8PYA004

This device contains a cellular RF module with IC : 23761-8PYA005

FCC Warning: This device complies with part 15 of the FCC Rules. Operation is subject to the following two conditions.

- (1) This device may not cause harmful interference.
- (2) This device must accept any interference received, including interference that may cause undesired operation.

Any changes or modifications not expressly approved by the party responsible for compliance could void the user's authority to operate the equipment.

This module complies with FCC radiation exposure limits set forth for an uncontrolled environment .This equipment should be installed and operated with minimum distance 20 cm between the radiator & your body.

The LoRaWAN antenna delivered by Wattsense meets the FCC-IC regulations. If the installer makes the choice to use another antenna, the maximum antenna gain allowed is 5.8 dBi to comply with FCC/IC regulations limiting both maximum RF output power and human exposure to RF radiation.

## CAN ICES-003 Compliance

This device complies with FCC and ISED RF radiation exposure limits set forth for general population. This device must be installed to provide a separation distance of at least 20cm from all persons and must not be co-located or operating in conjunction with any other antenna or transmitter.

This radio transmitter (23761-8PYA005 and 25908-RAK2247) has been approved by Industry Canada to operate with the antenna types listed below with the maximum permissible gain and required antenna impedance for each antenna type indicated. Antenna types not included in this list, having a gain greater than the maximum gain indicated for that type, are strictly prohibited for use with this device.

This device contains license-exempt transmitter(s)/receiver(s) that comply with Innovation, Science and Economic Development Canada's licence-exempt RSS(s). Operation is subject to the following two conditions:

- 1 This device may not cause interference, and
- 2 This device must accept any interference, including interference that may cause undesired operation of the device.

### Cellular antenna characteristics

- 1 Whip antenna type
- 2 50 Ohm typical impedance
- 3 Maximum antenna gain



## LoRaWAN antenna characteristics

Gain: 5.8dB

Frequency Band	Antenna Gain (dBi)
GSM850	-1
GSM1900	6
GPRS850 4TS	-1
GPRS1900 4TS	6
WCDMA Band2	10
WCDMA Band4	9
WCDMA Band5	7
LTE Band2	10
LTE Band4	11
LTE Band5	7
LTE Band7	10
LTE Band12	6
LTE Band13	6
LTE Band25	10
LTE Band26	8
LTE Band41	9
LTE Band66	9

## Radio common informations

GSM / GPRS / EDGE



850/900/1800/1900MHz 33dBm

LTE



850/900/1800/1900MHz 23dBm

LoRaWAN



WSG-EU-SC-14-00

WSG-NA-SC-14-00

EU868MHz

EU 915MHz / AS1 923MHz /  
AS2 923MHz

14dBm

14dBm





# ● Part 2 - Technical Datasheet

The Tower and the Bridge rely on the exact same electronic device:

- Created to connect all equipment from all buildings: IoT sensors, meters, heating, air conditioning, air handling systems, building management systems (BMS)
- Easy and quick to install: accessible for all. If the building already has a BMS, the box connects to the main bus as the third party. If there's no BMS, a BMS network is directly created by the box.
- Telemetry and controls: collects data and controls equipment.
- Smart Converter: unifies the field communication protocols.
- Web-Connected: automatically connects to the cloud via 3G/4G or ethernet cable.
- Powerful IoT device: combines the functionality of a gateway, a PLC, a modem, and an edge device.

## ● Power supply

- Stabilized power supply input: 85-264 V AC output: DC 24 V +/-10% / 2 A
- The cable between the power supply and the device: 2 wires (red, black), 22 AWG, minimum section: 0.35 mm<sup>2</sup>.
- Protection against overvoltage, undervoltage, and overcurrent from the power supply with indication by LED: green LED when the power supply is compatible, red LED if it is not suitable.

## ● Hardware

CPU:	528MHz ARM Cortex A7
Memory:	512MB RAM
Storage:	4GB Flash
Consumption:	5W
Dimension:	160 × 110 × 55 mm (without antennas) 160 × 110 × 95 mm (with antennas)
Weight:	350g - 385g with antenna
Operating temperature:	From 0°C to +45°C
Humidity:	5% to 95% humidity - No condensation
IP Code	IP2X
Mounting:	-DIN rail Omega profile (TN35) DIN 1015 / 1070 / 3070- Wall mounted (2 screws)

# Interfaces

Type of interface	Quantity	Operating LEDs	
Cellular modem	1	Yes	<ul style="list-style-type: none"> <li>● Not connected</li> <li>☀ every 1.2s Connected</li> <li>☀ every 0.4s Communicating</li> </ul>
LoRaWAN module from 863MHz to 928MHz	1	No	
Ethernet RJ45	2	Yes	<ul style="list-style-type: none"> <li>● Communicating</li> <li>● Not communicating</li> </ul>
RS485	2	Yes	<ul style="list-style-type: none"> <li>● Communicating</li> <li>● Not communicating</li> </ul>
USB	2	No	
USB Micro	1	No	
KNX	1	Yes	<ul style="list-style-type: none"> <li>● Communicating</li> <li>● Not communicating</li> </ul>
M-Bus	1	Yes	<ul style="list-style-type: none"> <li>● Communicating</li> <li>● Not communicating</li> </ul>
LPB/BSB (X-Bus)	1	Yes	<ul style="list-style-type: none"> <li>● Communicating</li> <li>● Not communicating</li> </ul>

Protection of communication bus against ESD, short circuit, overconsumption.

## Other LEDs

Power Supply	1	Yes	<ul style="list-style-type: none"> <li>● Power supply OK</li> <li>● Power supply NOK</li> </ul>
Heartbeat	1	Yes	<ul style="list-style-type: none"> <li>☀ Box working</li> <li>● Box not working</li> </ul>

# Drivers

- BACnet IP
- BACnet IP Server
- Diematic
- KNX S et LTE
- LON IP-852
- LPB
- LoRaWAN 1.0 Local private - Frequency plans supported:  
WSG-EU-SC-00-14 : EU863-870, IN865-867  
WSG-NA-SC-00-14 :US902-928, AS923-925, AU915-928
- M-Bus (3UL Max.)
- Modbus RTU
- Modbus TCP/IP
- Modbus TCP/IP Server
- MQTT Client



## Software

- Secured Linux Yocto distribution.
- Built-in drivers for all buses, protocols, and building equipment.
- Automatic discovery of equipment on BACnet.
- Remote and automated configuration.
- Secure server communication via MQTT.
- Automatic and secure software updates.

## Security

Enterprise-grade security based on SSL/TLS with the following properties:

- Two-way authentication between box and server with x509 certificates.
- End-to-end encryption.
- Message integrity checks.

## Data frequency

Data is read by default at a 10-minute interval, excluding IoT sensors that have their own frequencies to minimize battery consumption. Commands (downlink) are sent instantly.



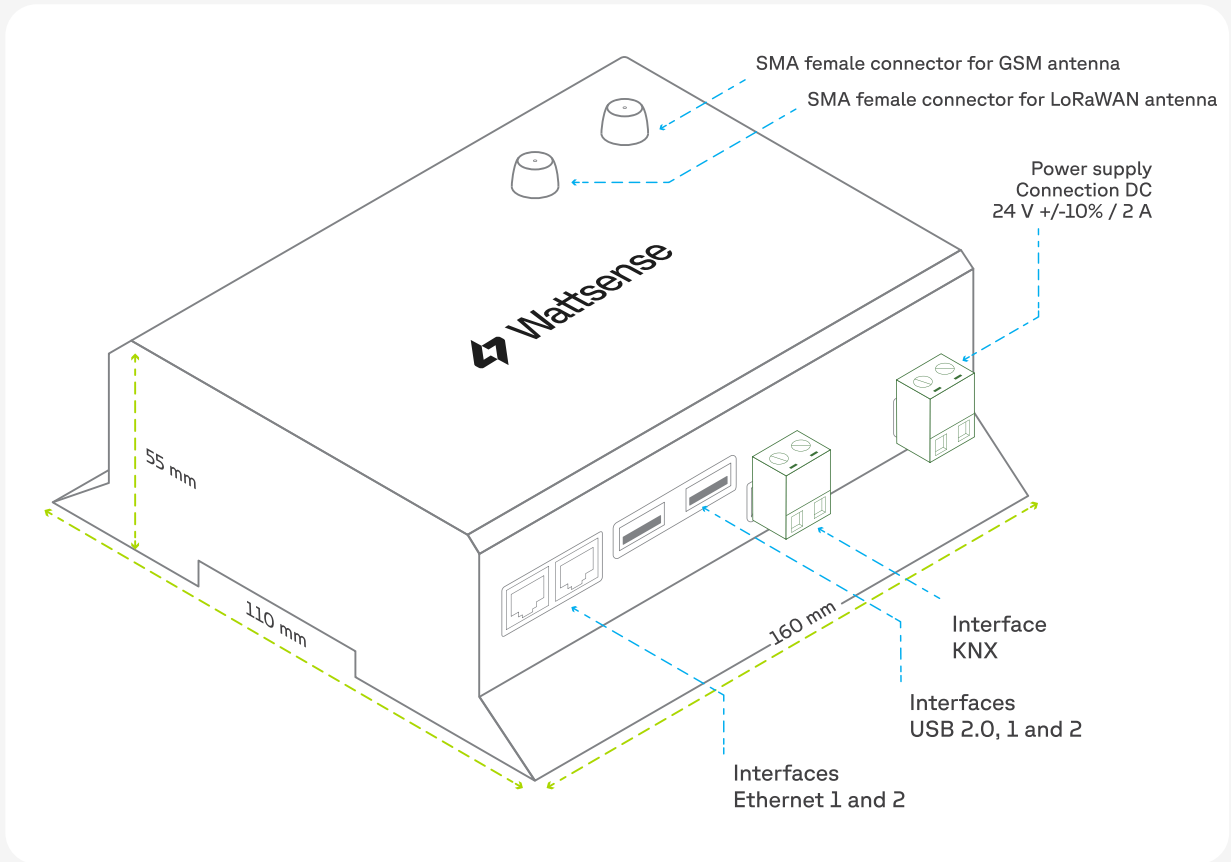
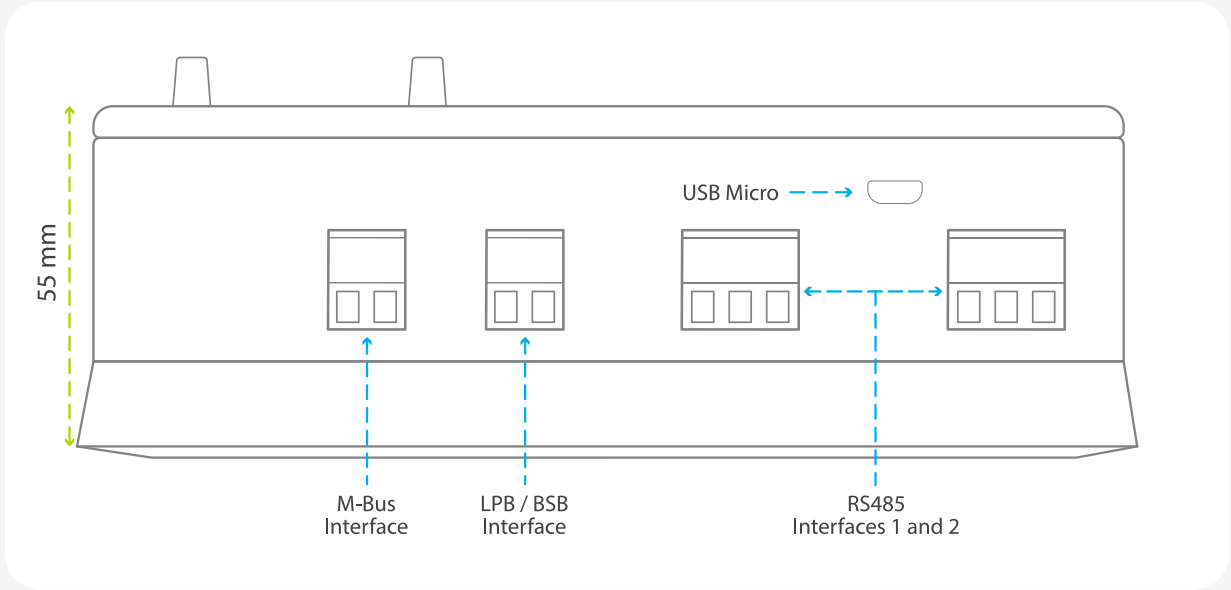

# Part 3 - Installation Guide

What do you need before starting?

## Provided material

1. Box  
Dimensions: 160 x 110 x 55 mm (without antennas)  
Weight: 350 g - 385 (with antennas)
2. GSM standard antenna
3. LoRa standard antenna
4. Info card

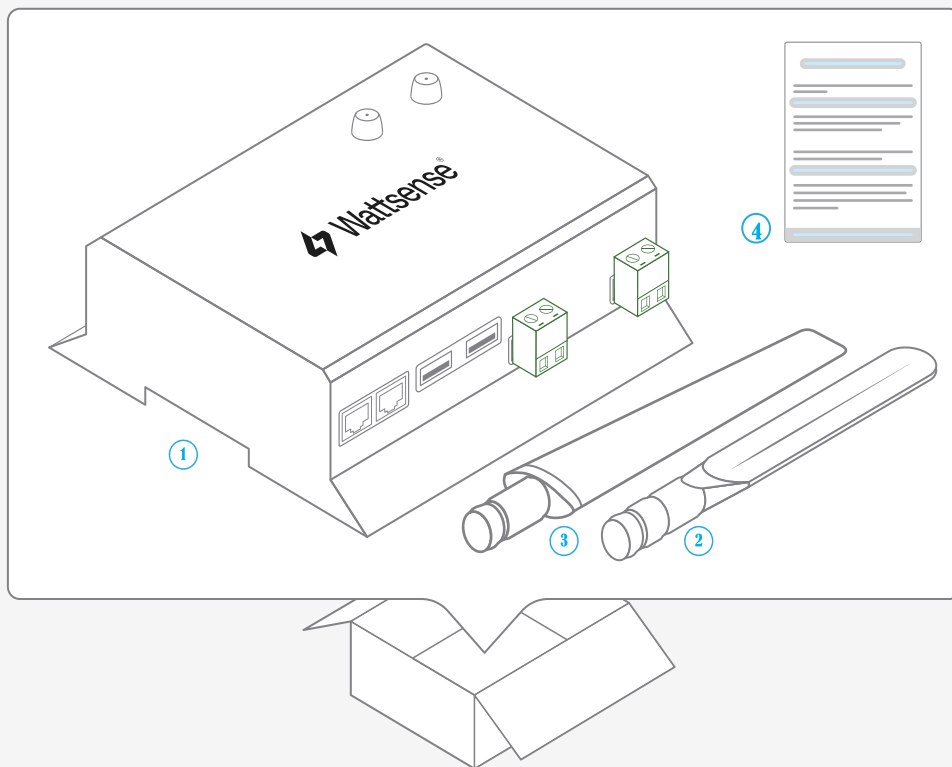

## Required material

- Stabilized power supply input: 85-264 V AC output: DC 24 V +/-10% / 2 A
- Cable between the power supply and the device: 2 wires (red, black), 22 AWG or 0.35 mm<sup>2</sup>
- Flat screwdriver
- Cutting pliers
- Wire stripper

## Optional hardware depending on the type of connection

- Bus connection cable: 2 wires, 24 AWG, minimum section: 0.22 mm<sup>2</sup> + braid
- Ethernet cables
- Ethernet switch
- High-gain GSM antenna
- High-gain LoRa antenna
- GSM or LoRa antenna cable
- Double-sided high performance adhesive tape
- Technical documentation of equipment
- Technical documentation of IoT sensors
- Schematic of the communication network(s) of the BMS

## Computer access to the Wattsense console

- Each customer has a dedicated space on the Wattsense User Console at <https://console.wattsense.com>. This interface allows them to manage their fleet of boxes.
- A box must have been activated in advance before it can be fully installed and configured.
- A box can be installed on-site before being activated but you won't be able to assess that the data is coming through.
- If the box hasn't been activated, ask the administrator of the account to create an "installation" access on the Wattsense user console and retrieve the login information (email address and password).
- Once on-site, activate the box on the console:
  - Log in to the console: enter the email and password provided by the administrator and click on "Log in".
  - Enter the alphanumeric identifier of the box in the search rectangle at the top.
  - Click on "Activate".
  - It is required to give the box a name in the "Name" field (for example, the name of the site where it will be installed).
  - If necessary, add additional information in the "Description" field in order to clearly identify the box (for example the floor or the exact location of where the box is installed if there are several boxes on the same site).
  - Click on "Activate the box".
- You can then access the configuration tools.

# ● The power supply of the box

Make sure that the device has been activated beforehand on the user console.

- Ideally, place the box in an electrical enclosure or cabinet.
- This type of equipment is not suitable for installation in places that can accommodate children.
- Attach the box:

Mount the box on a DIN rail

Push the RAIL DIN lock

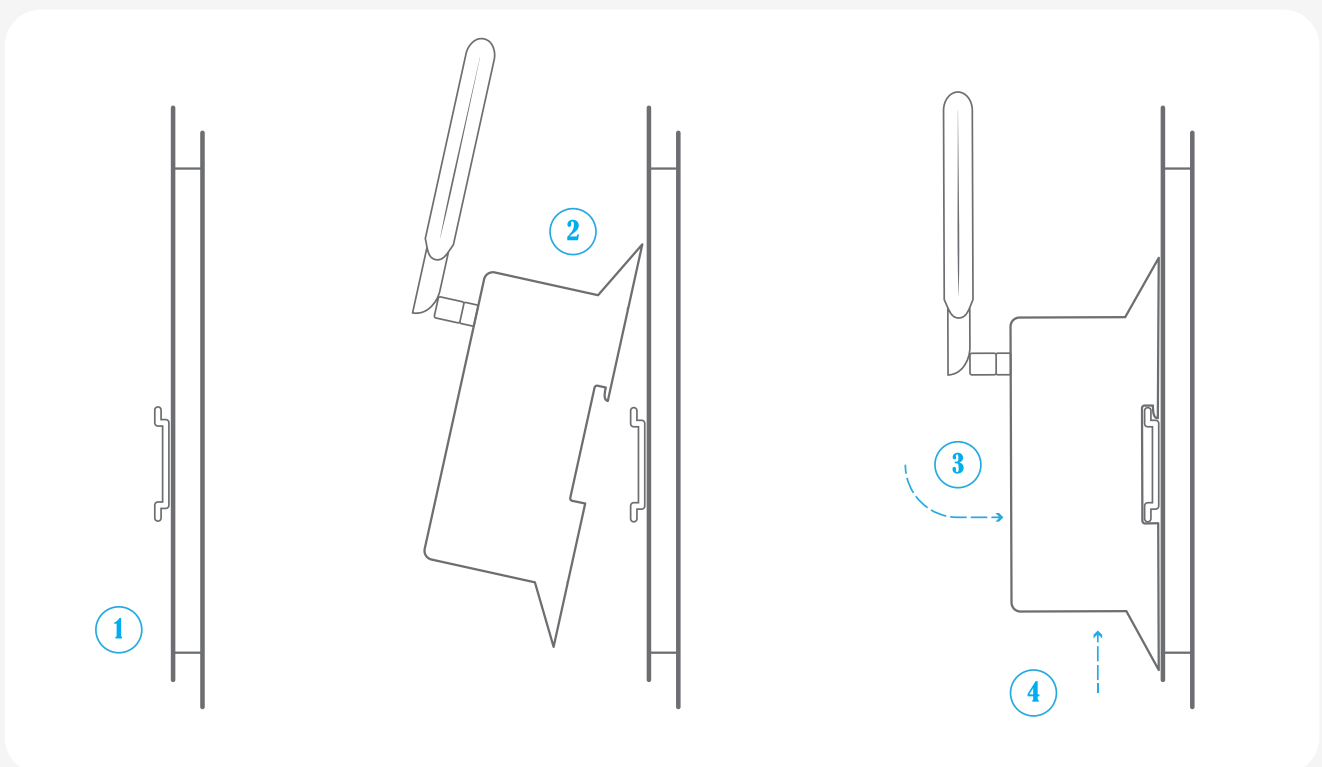

- To avoid any risk of injury caused by a fall, the box should not be installed more than 2 meters from the ground.
- Use a stabilized power supply input: 85-264 V AC output: DC 24 V +/-10% / 2 A
- Attach crimping ferrules to both wires
- Screw the cable into the power connector of the box

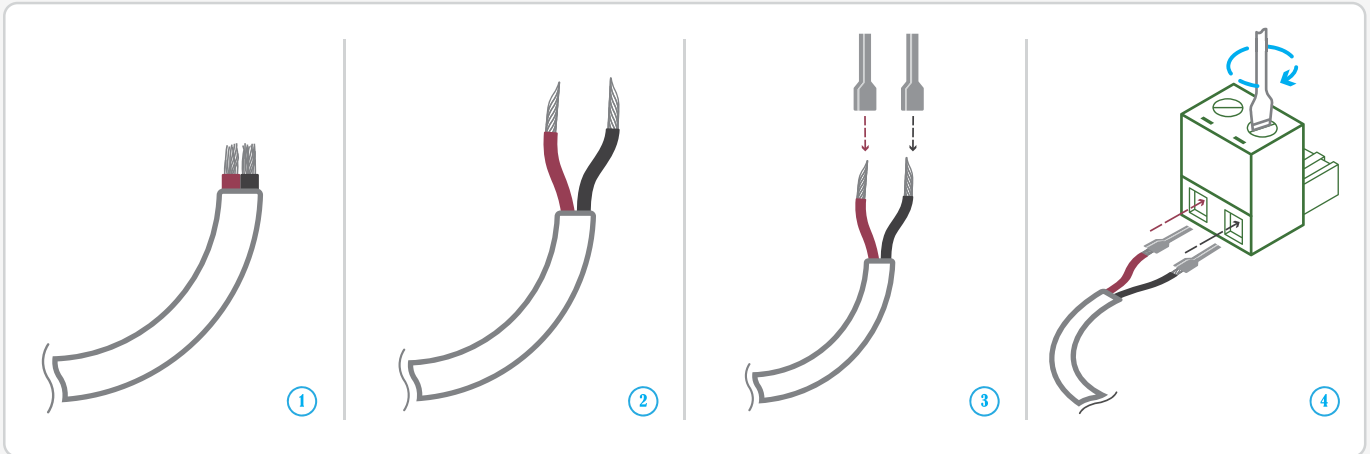

- Connect the cable to the power supply.

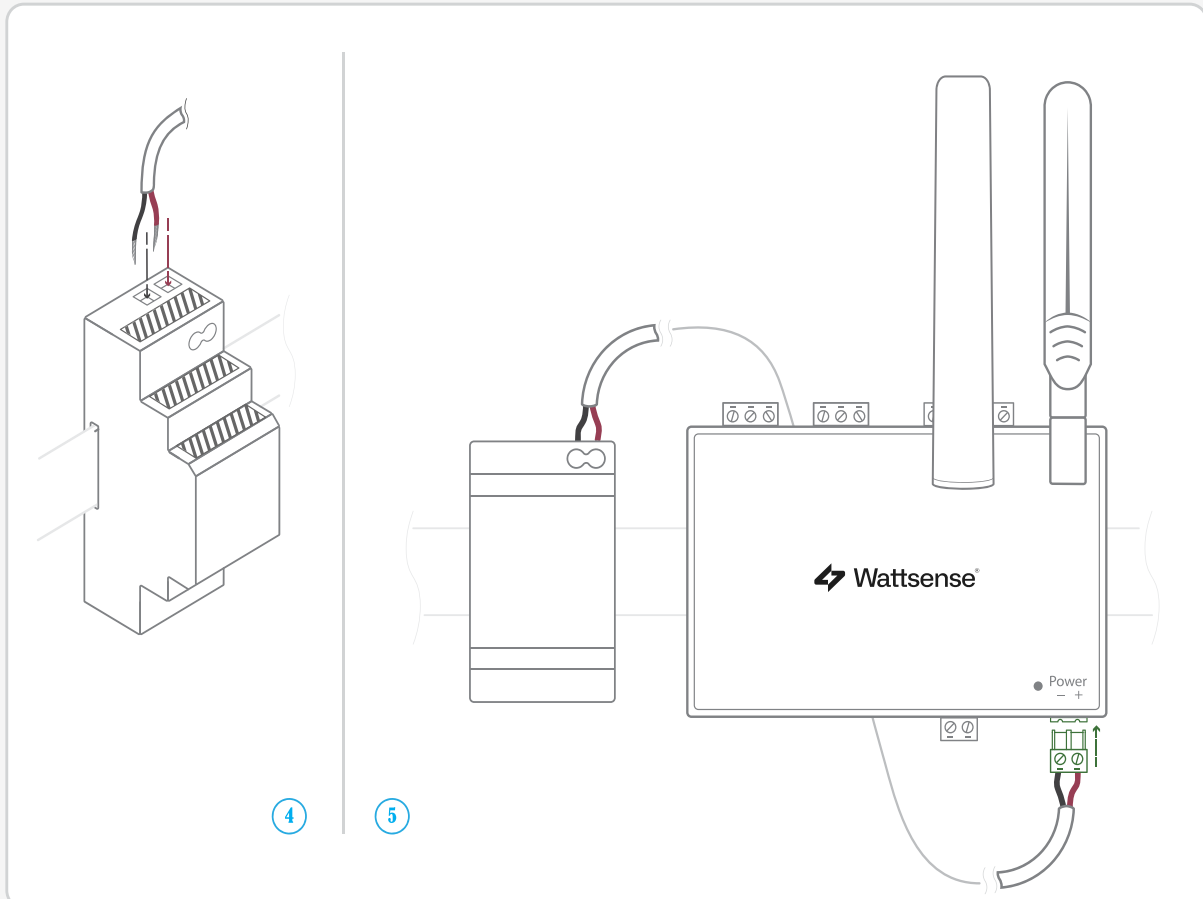



- Check that the "Power" LED is lit (steady green light).

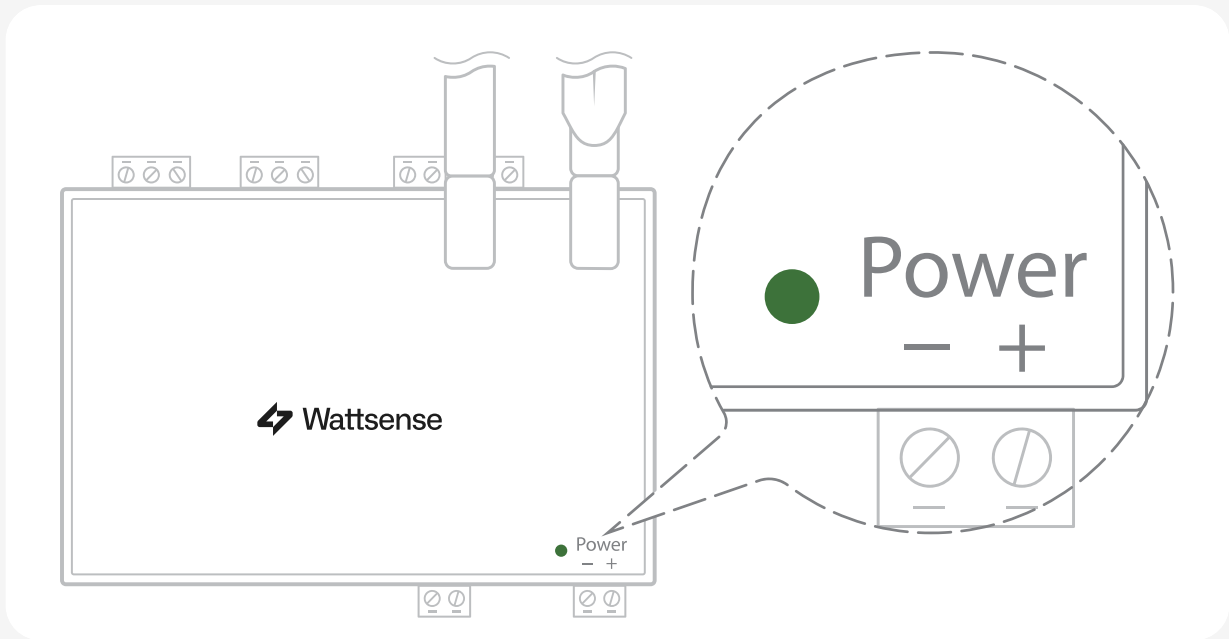

- Wait about 10 seconds: the "Heartbeat" LED flashes (green light).

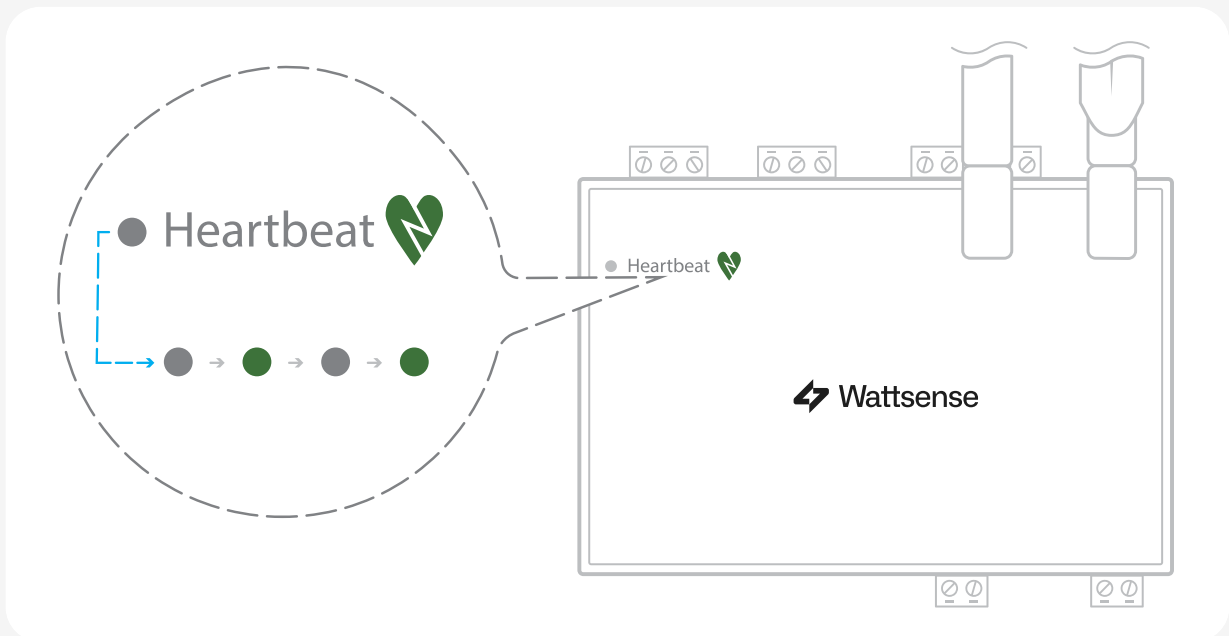

- Wait until the GSM LED flashes; if the LED does not flash after a few minutes, see the chapter of the GSM antenna.

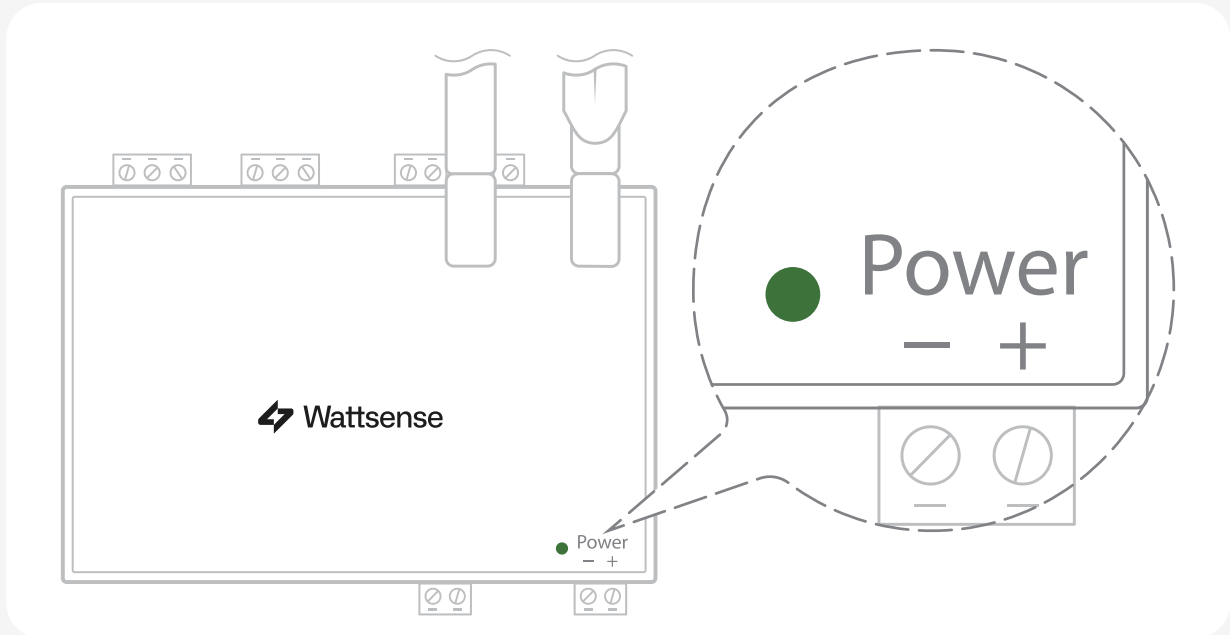

- Check that the box appears on the console: the presence indicator of the box changes from red to green.
- If the box appears on the console, it is functional; you can go to the connection step of the box to the equipment and/or the network of the building.
- If the box does not appear on the console, see the GSM Antenna chapter.

# GSM Antenna

The box is supplied with a standard GSM antenna.

For the United States, please use an antenna with a gain not exceeding that shown in the table below:

Frequency Band	Antenna Gain (dBi)
GSM850	-1
GSM1900	6
GPRS850 4TS	-1
GPRS1900 4TS	6
WCDMA Band2	10
WCDMA Band4	9
WCDMA Band5	7
LTE Band2	10
LTE Band4	11
LTE Band5	7
LTE Band7	10
LTE Band12	6
LTE Band13	6
LTE Band25	10
LTE Band26	8
LTE Band41	9
LTE Band66	9

- If the quality of the GSM signal is good: keep the original antenna installed on the box.

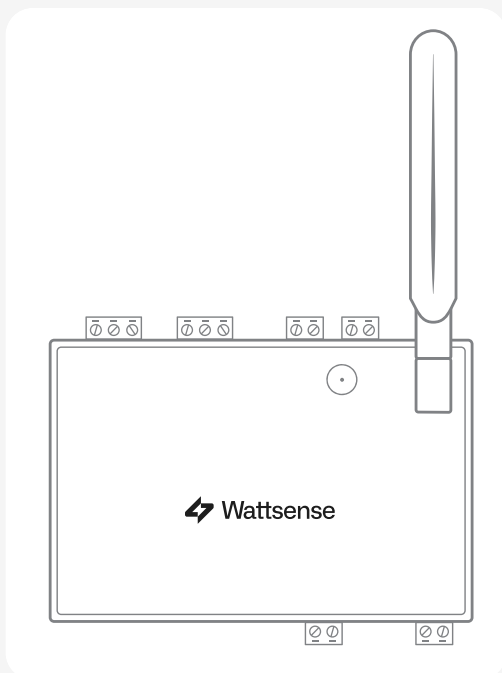

- If the signal quality is insufficient: move the original antenna out of the cabinet; use an RF extension cord with SMA connector, up to 2 meters, + 1 adhesive support to hold the antenna.
- If the signal quality is still insufficient: use a high-gain antenna with a maximum of 10 meters of cable; this antenna can, for example, be moved to the outside or to the other floors to obtain a better signal quality. Please note that, beyond 15 meters of cable, the GSM signal is significantly weakened.

# ● Antenna position (USA)

For an installation in the United States of America, the GSM antenna and the LoRa antenna must be positioned at 90° to each other.

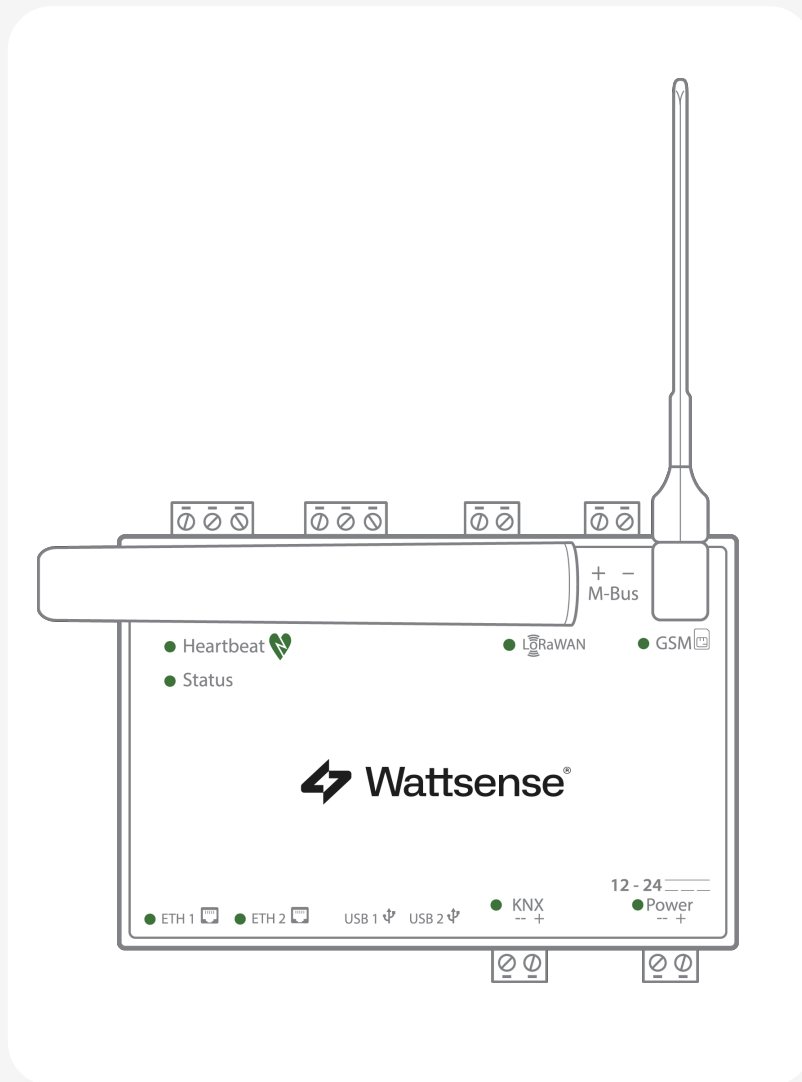

# To connect the box to the BMS

- Determine the type(s) of network(s) associated with the BMS (communication protocols between the BMS server and the technical equipment).
- Obtain, if possible, the schematic of the communication network(s) of the BMS.
- Identify where and how the BMS server connects to the building's network.

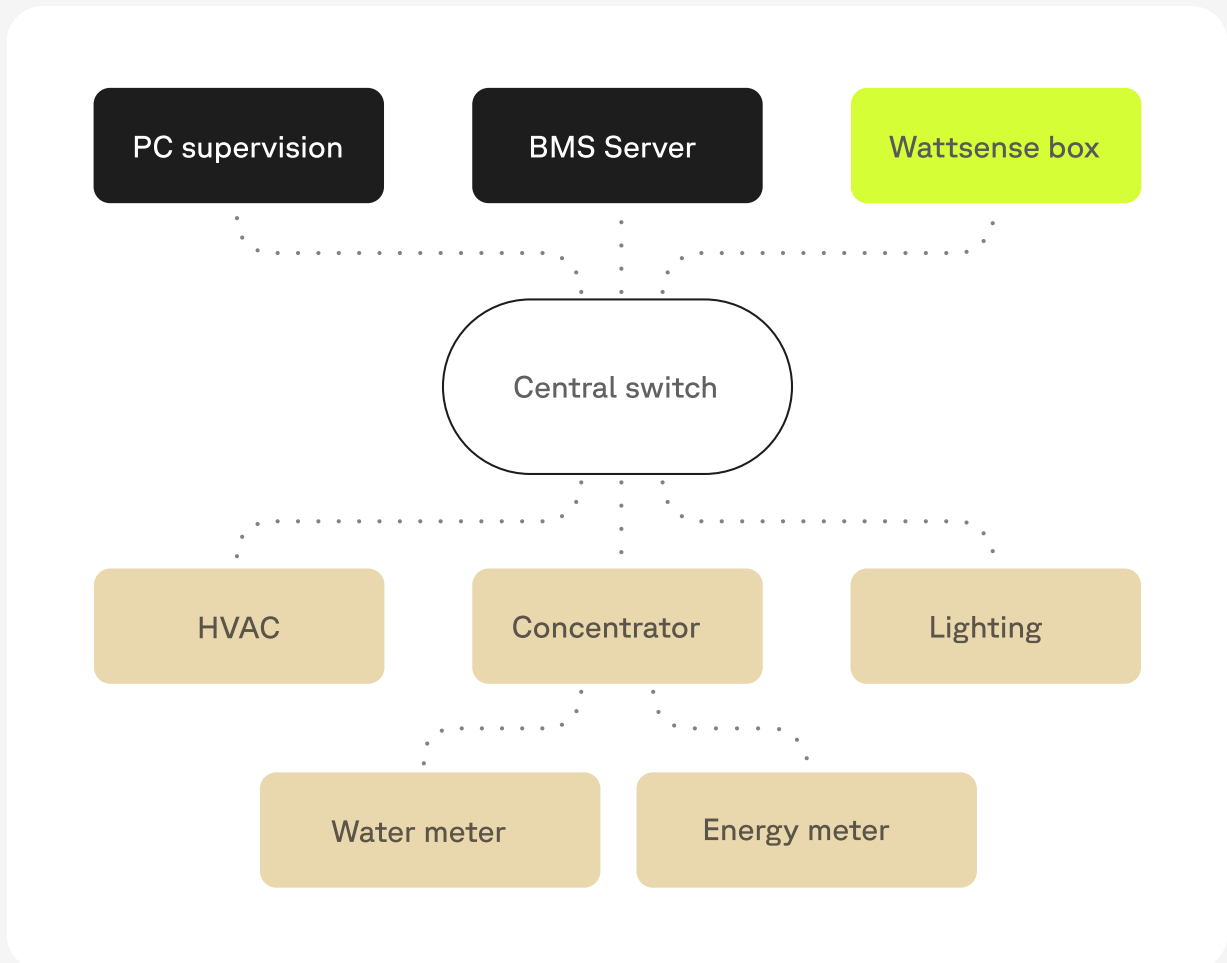

# ● In case of IP network (Except LON)

## Connection:

- Make sure to have an Ethernet cable.
- Connect the cable to the Ethernet port of the box ETH1 or ETH2.

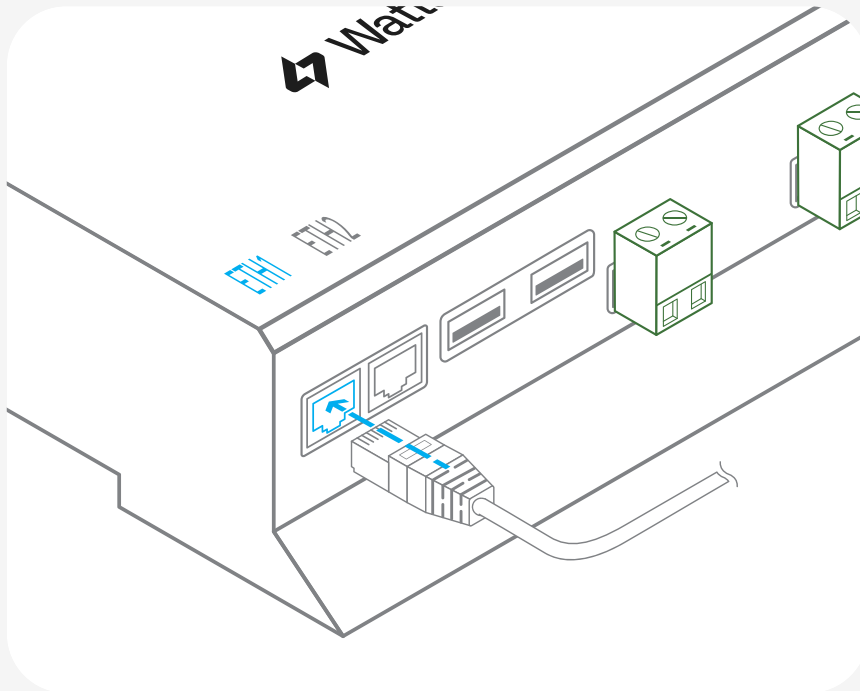

- Connect the box to the switch (IP network) on which the supervision PC/BMS server is connected.
- Check that the ETH1 or ETH2 LED lights up.

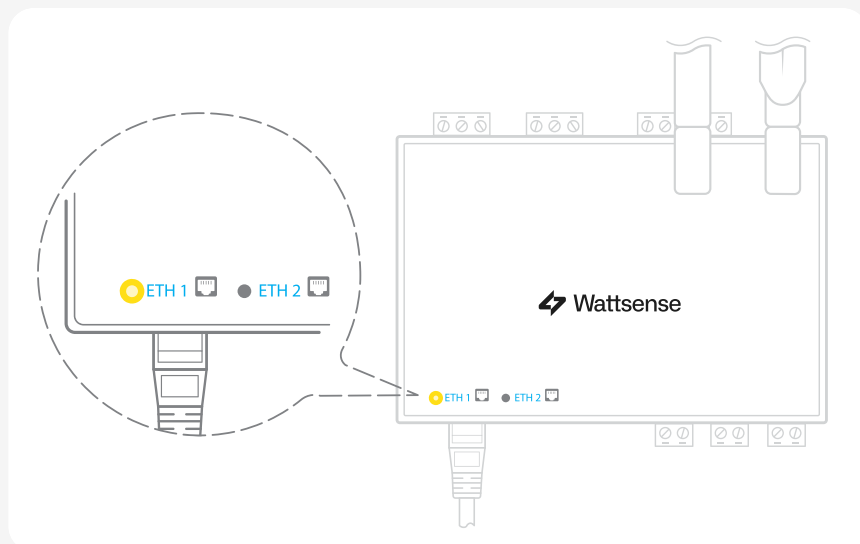

### **Configuration:**

- If there is no DHCP server on the network, attribute a static IP address, its mask and the gateway if necessary to the box (Discuss with the building's IT manager).
- If there is a DHCP server on the network, the address is automatically assigned.

### **Information to retrieve in preparation for the configuration:**

- For each device that communicates in Modbus IP
  - From the BMS software, perform an extract of the available properties: list the data types provided by the different devices to which the BMS has access.
  - If it is impossible to retrieve this information, get the IP address and TCP port (and if needed, for some devices, the slave address (Slave ID), the brand, and model of the equipment, and extra identifying information. This information is necessary for the installation configuration and to retrieve data.
- In the case of a BACnet IP network
  - Write down the BACnet port of the network. This information will be necessary for the installation configuration and to retrieve data.



# ● In case of LON IP-852

## Connection:

- Make sure to have an Ethernet cable
- Connect the cable to the Ethernet port of the box ETH1 or ETH2.

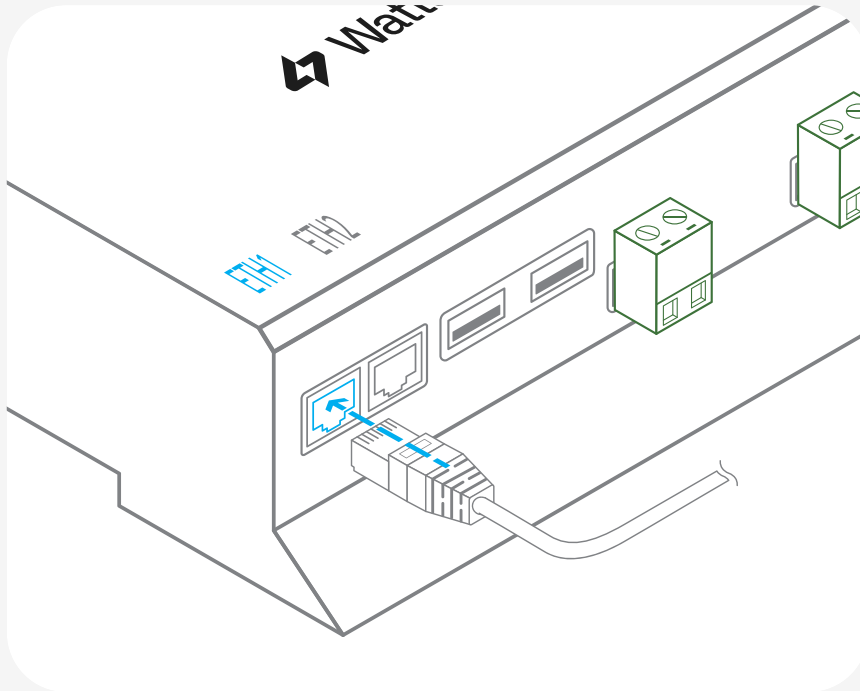

- Connect the other end of the cable to the IP-852 server on the LON network.

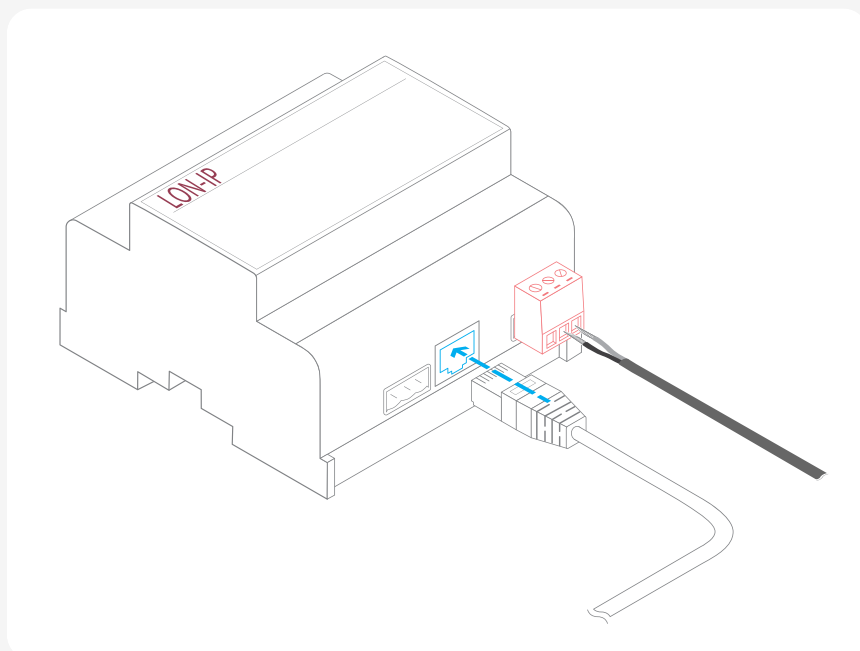



- Verify that the ETH1 or ETH2 LED lights up

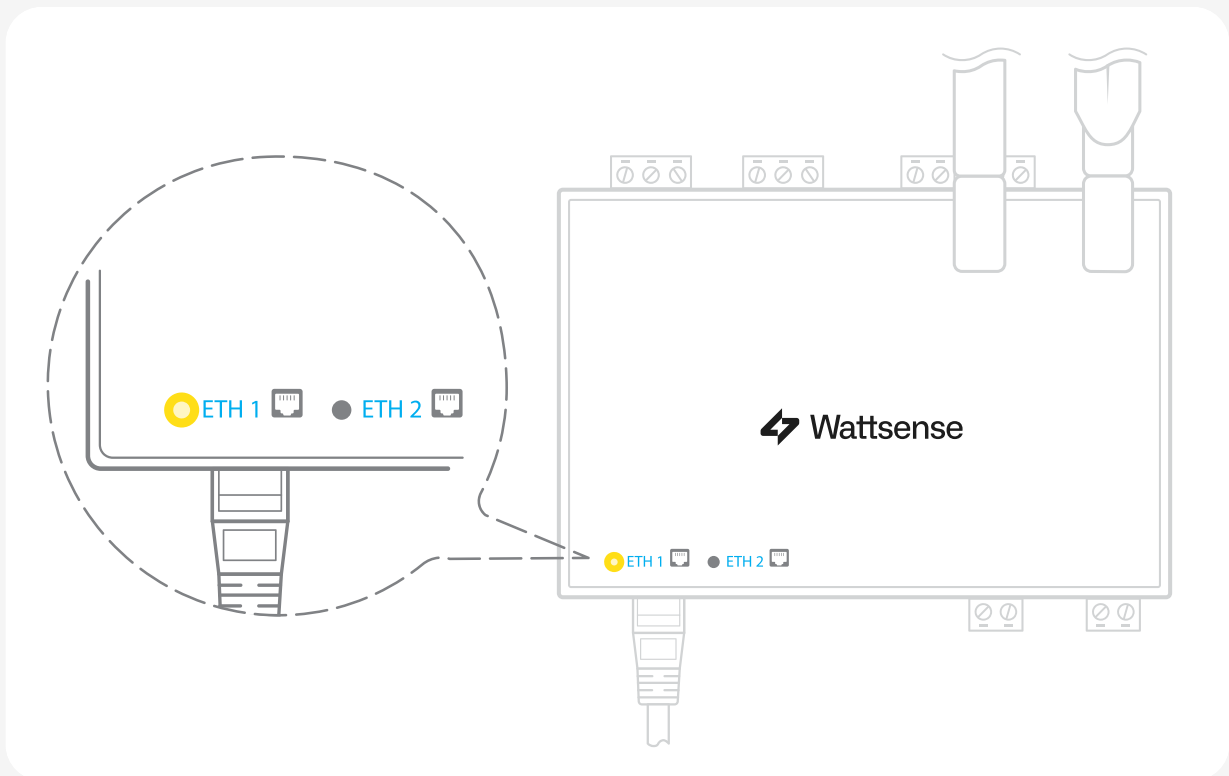

- Register the IP address of the box on the IP-852 server of the LON network; the IP-852 server's password is probably required.

Information to retrieve in preparation for the configuration phase:

- Write down the Neuron-ID, brand and model of the equipment, and any identifying information. This information will be necessary for the installation configuration and to retrieve data.
- If you have the NL220 software, export the LON database as an archive file or as an NLC file.

## ● To connect the box directly to the technical equipment in the absence of a BMS

- Prepare the list of equipment to be connected and their respective communication protocols.
- Collect the technical documentation of each manufacturer to know where and how to connect to its devices (user console, configuration wizard, manufacturer's site, etc.).
- Draw up an installation schematic.



# • The equipment communicates in Modbus IP

To connect only one equipment

- Make sure to have an Ethernet cable.
- Connect the cable to the Ethernet port ETH1 or ETH2.

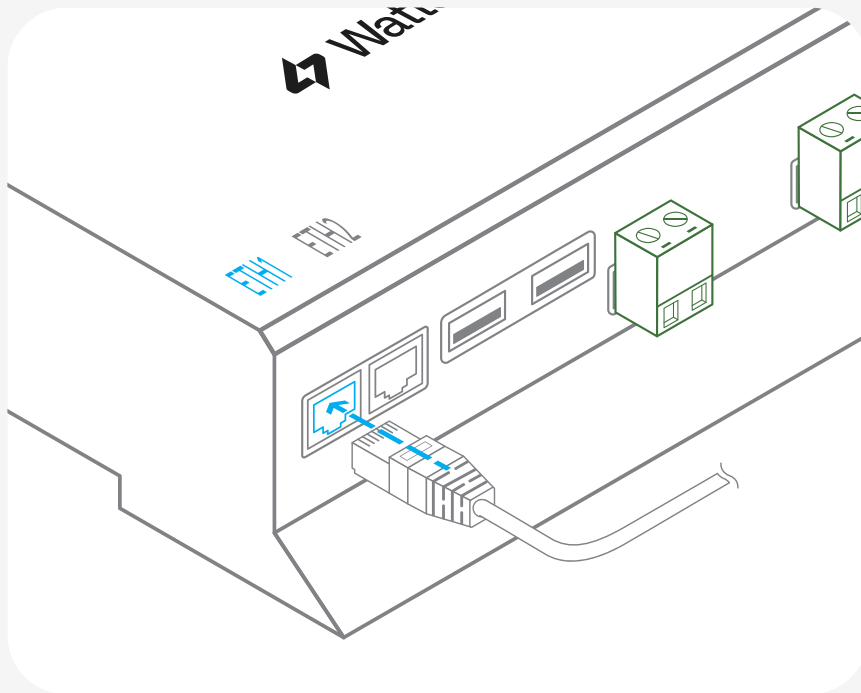

- Connect the other end of the cable to the equipment.
- Verify that the ETH1 or ETH2 LED lights up.

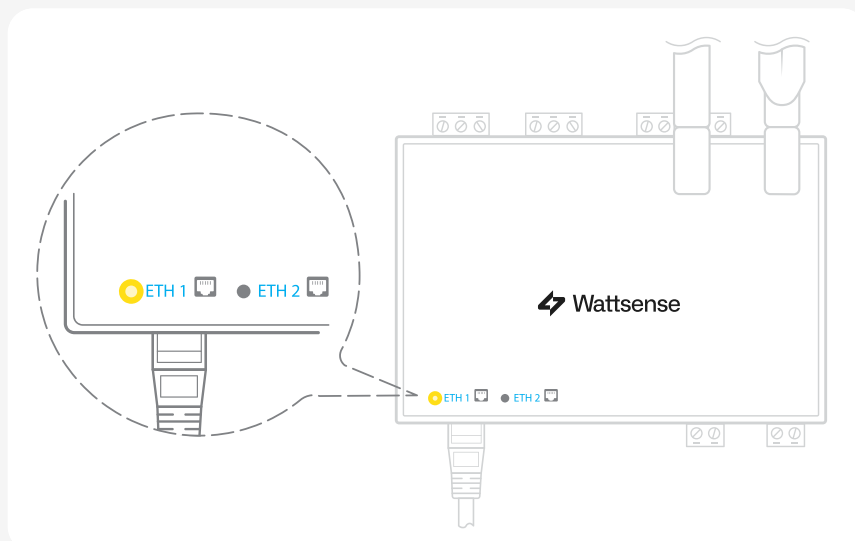

### To connect two devices

- Make sure to have 2 Ethernet cables.
- Connect the cables to the Ethernet ports of the box ETH1 and ETH2.

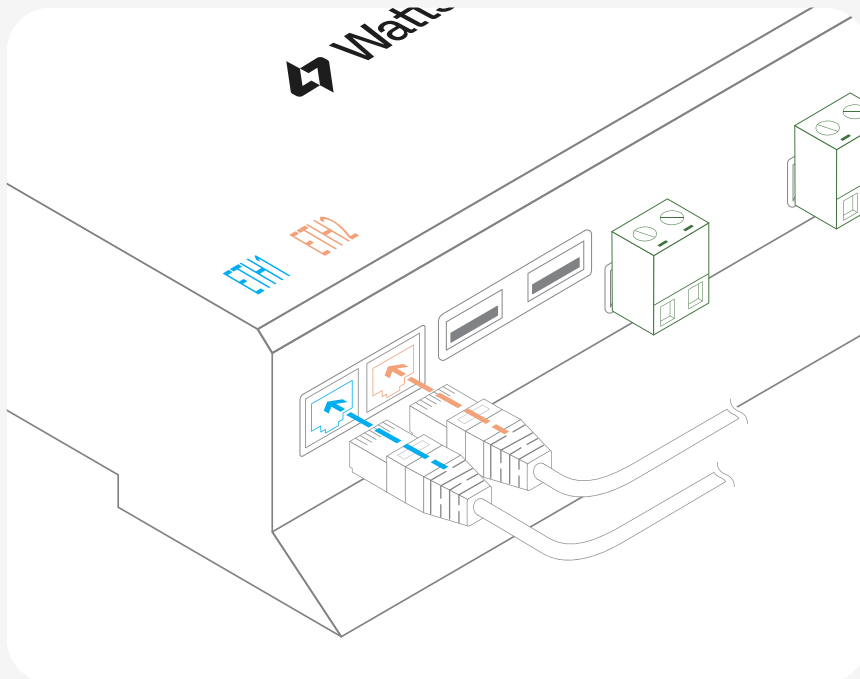

- Connect the cables to the 2 Modbus devices.
- Check that the ETH1 and ETH2 LEDs light up.

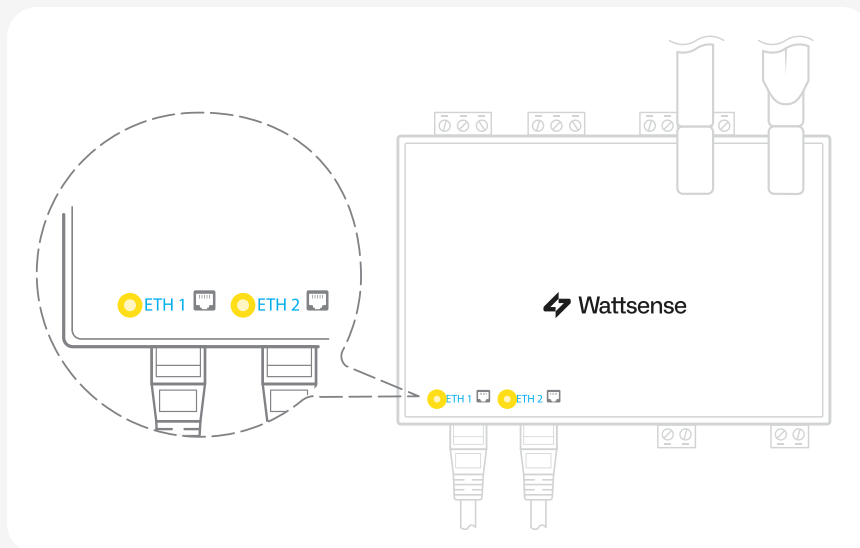

To connect three equipment or more make sure to:

- Have an Ethernet cable for the box.
- Have as many Ethernet cables as equipment to connect.
- Have an Ethernet switch.
- Connect the switch to the power supply

- Connect an Ethernet cable to the Ethernet port of the box ETH1 or ETH2.

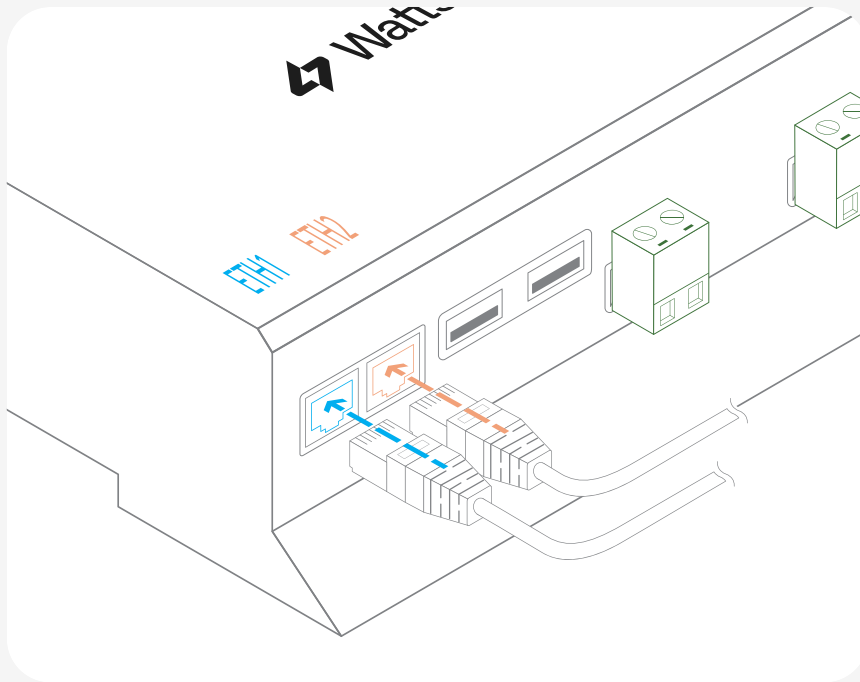

- Connect the other end of this cable to the Ethernet switch.

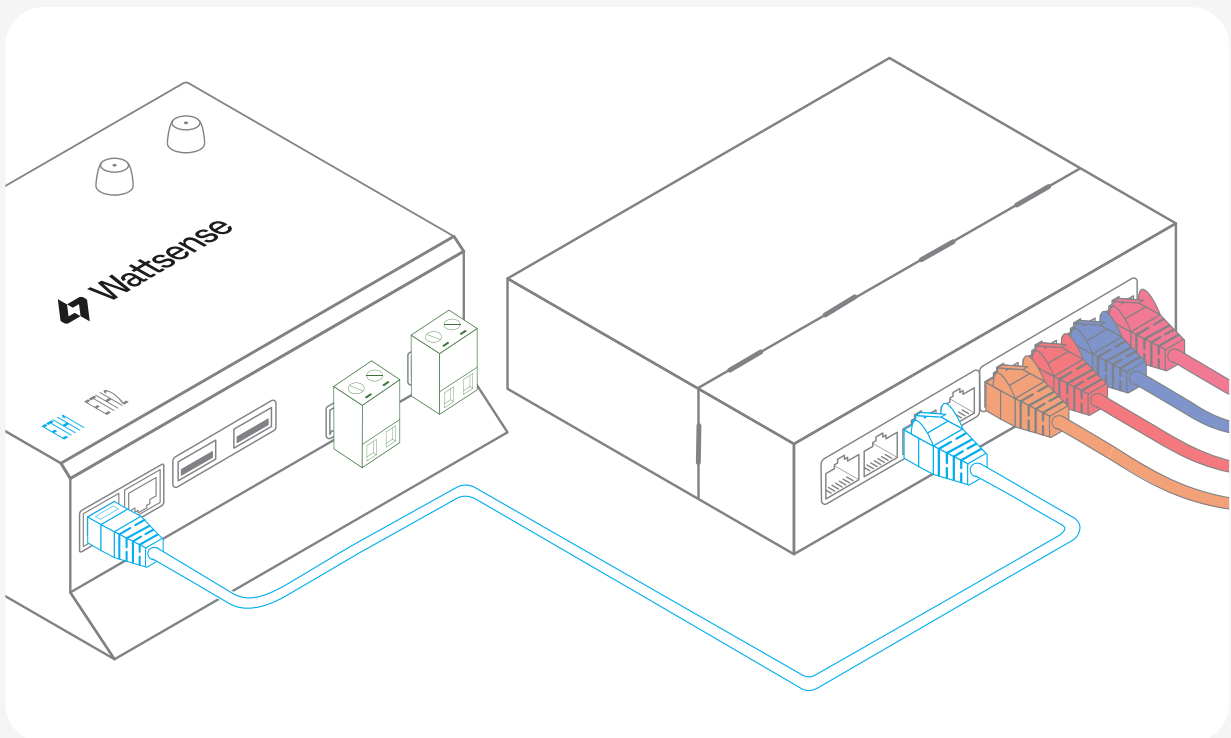

- Check that the ETH1 or ETH2 LED lights up.

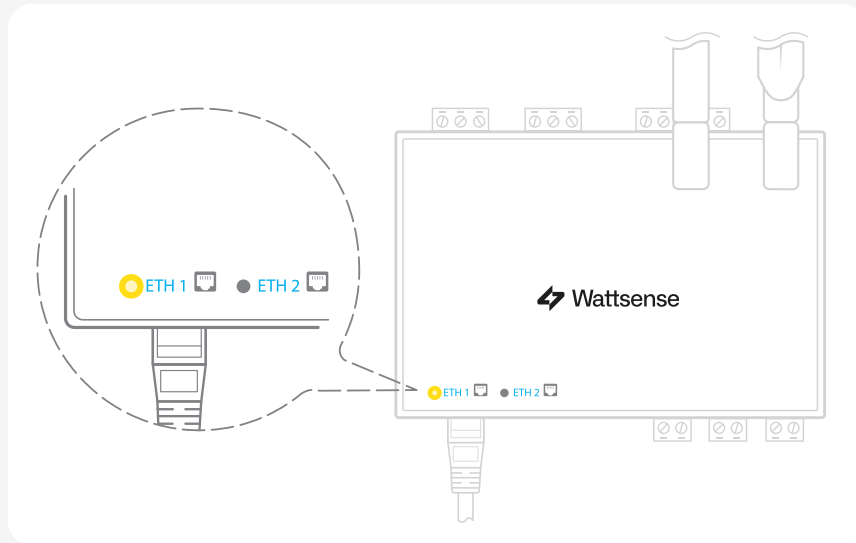

- Connect all equipment to the switch via the Ethernet cables.

#### To configure each one of the equipment:

- Using the technical documentation of the equipment, find its IP address and TCP port (and if necessary, for some devices, the address of the slave "Slave ID").
- If the equipment does not have an IP address, assign one to it, 192.168.1.1 for the first device, then 192.168.1.2 for the second device, 192.168.1.3 for the third device, and so on.
- Write down the IP address and TCP port (and if necessary, for certain devices, the address of the Slave ID), the brand and model of the equipment, and any information that allows it to be identified. This information will be necessary for the installation configuration and to retrieve data.

## • The equipment communicates in Modbus RTU (RS485)

#### Organization of the Bus architecture:

- Gather the necessary information for each device: Bus speed, character size, parity bit, stop bit (from the user console's configuration wizard, from the manufacturer's technical documentation, or directly from the control panels of the equipment).
- The goal is to create a maximum of two networks, each grouping equipment with the same communication configuration and assign them to the two RS485 ports of the box.
- If the characteristics of the equipment require to set more than two homogeneous networks, it is necessary to order another box.

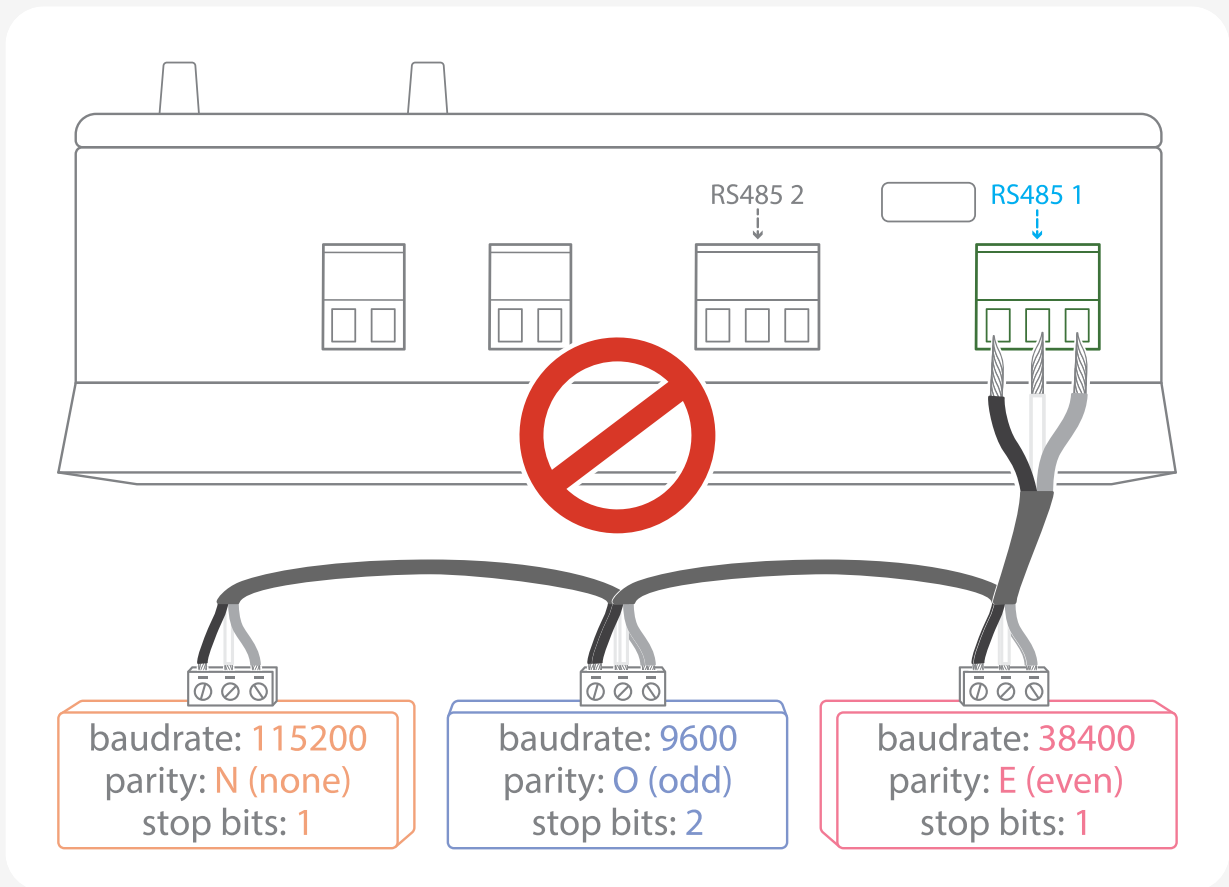
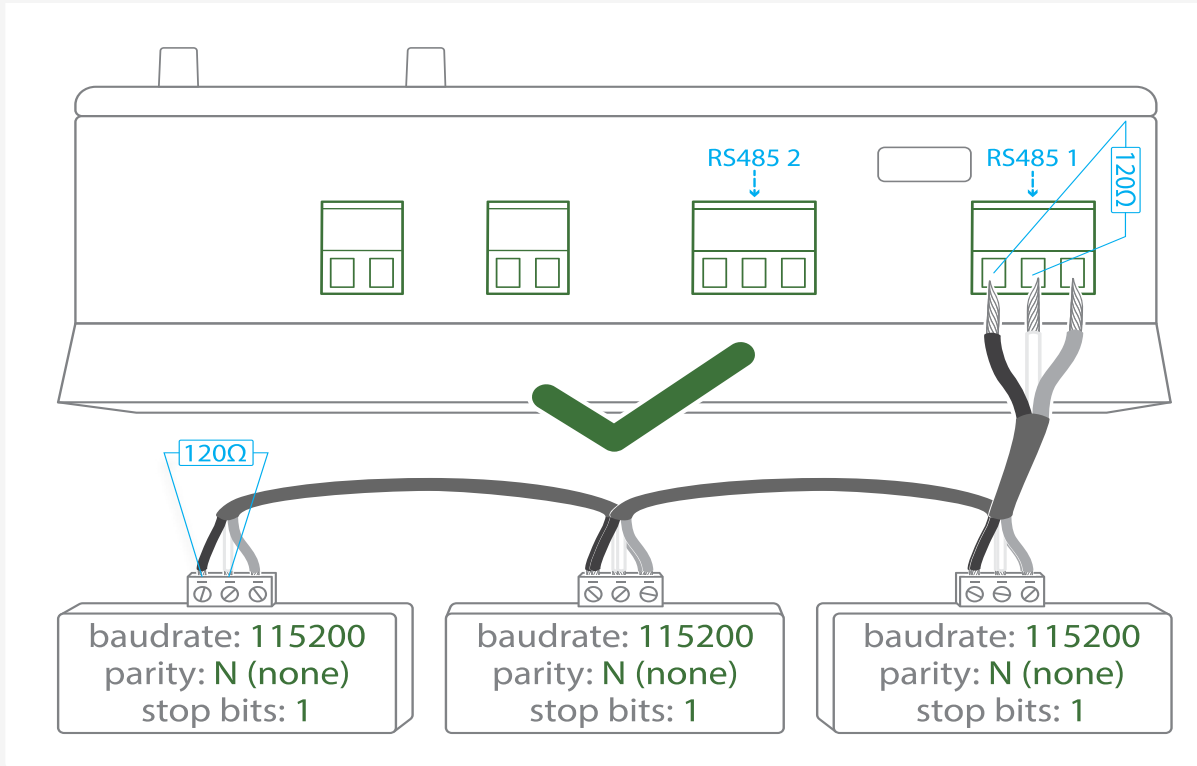

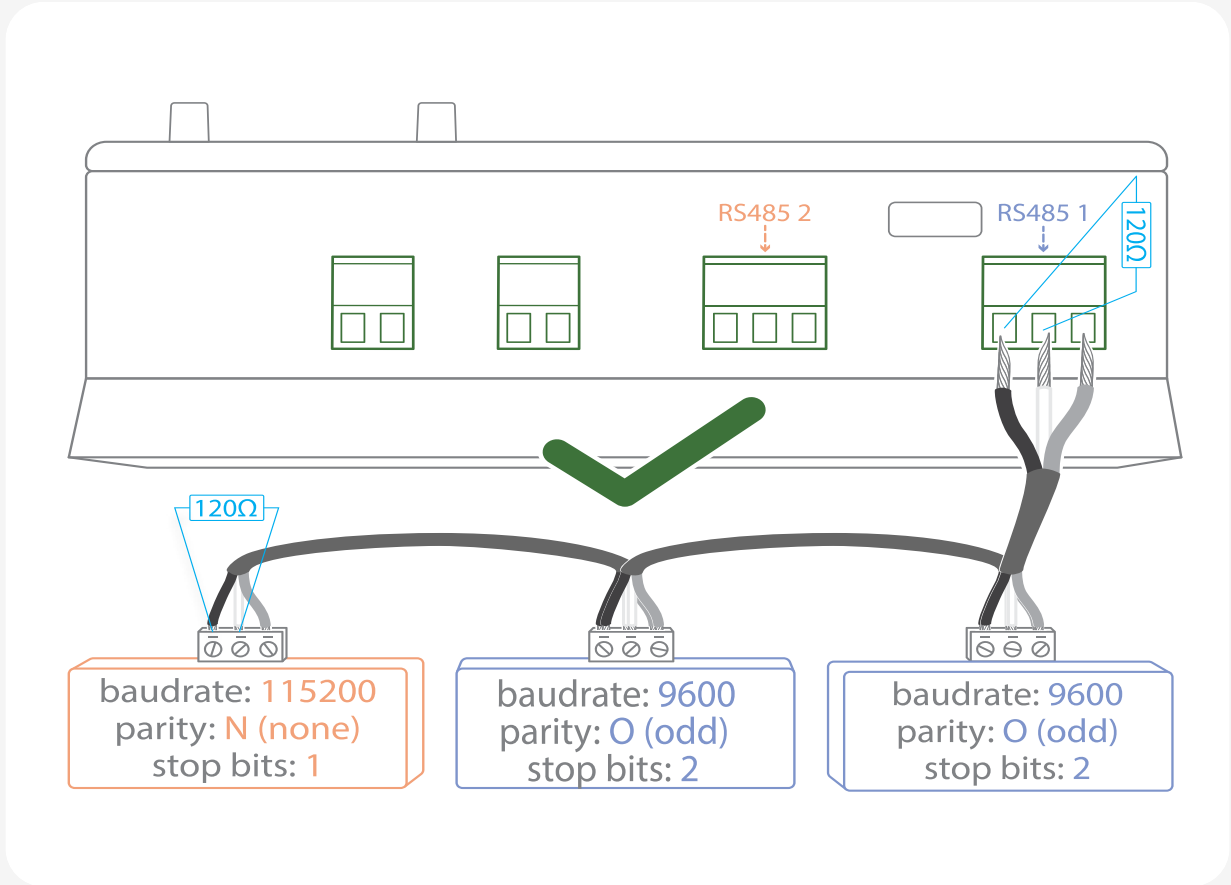

**To connect the equipment:**

- Caution: Do not group together devices with different communication parameters on the same Bus.

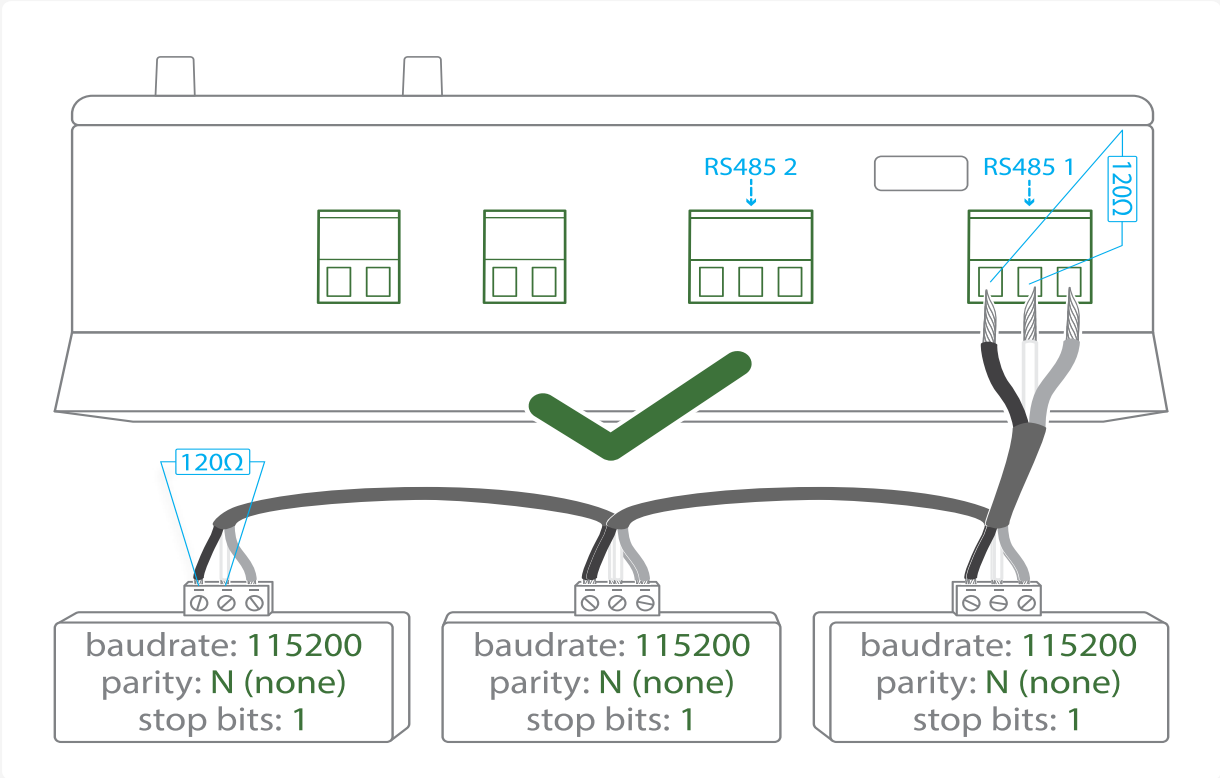



- Serial wire the network or each of the two networks.

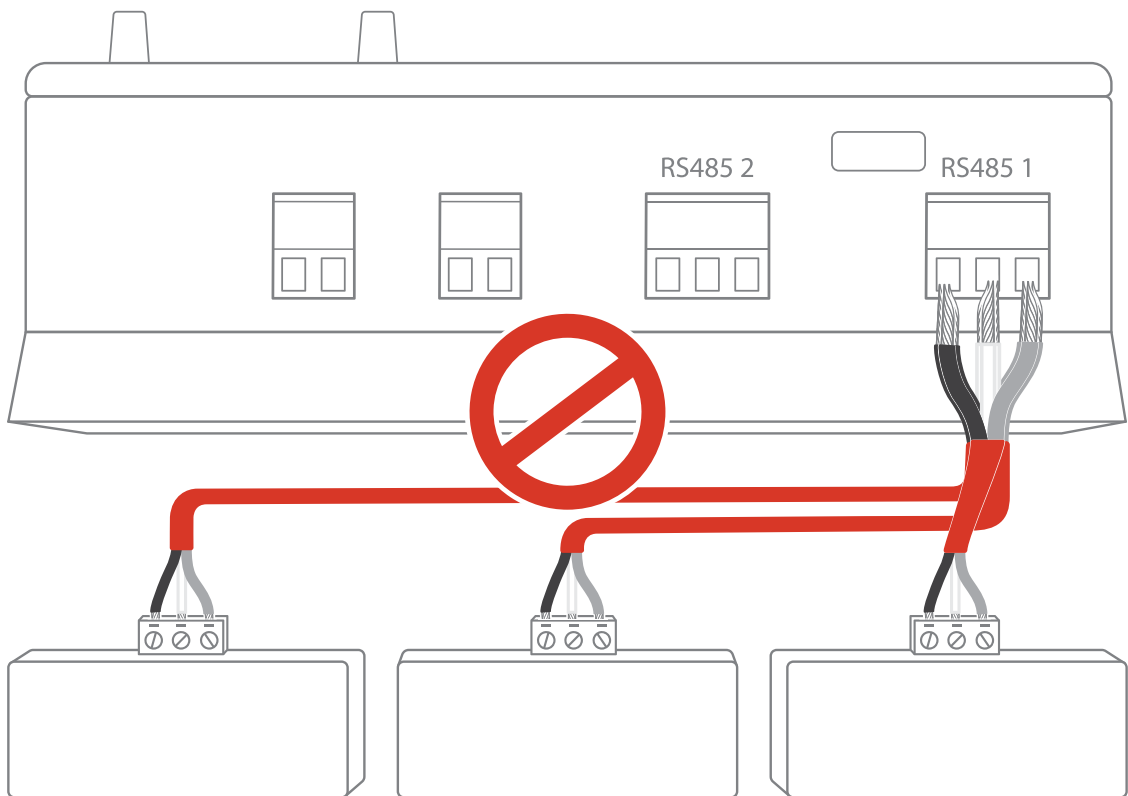
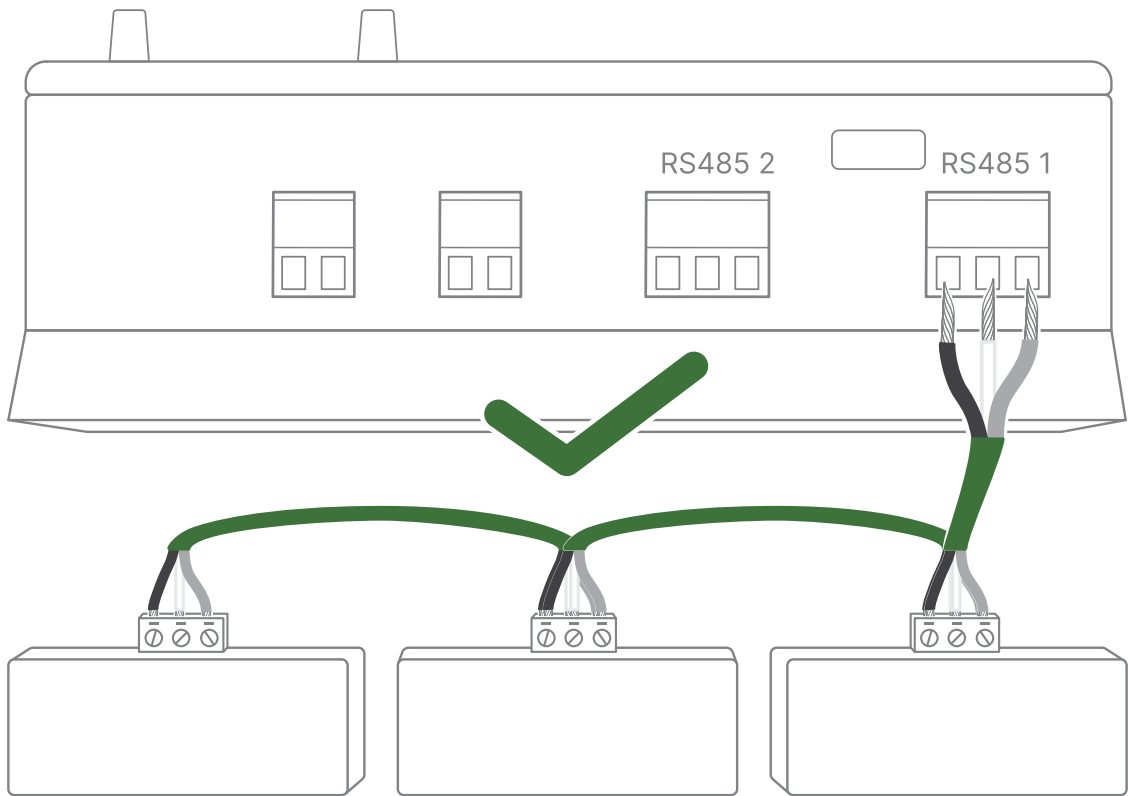

- Connect the network to one of the two RS485 ports of the box

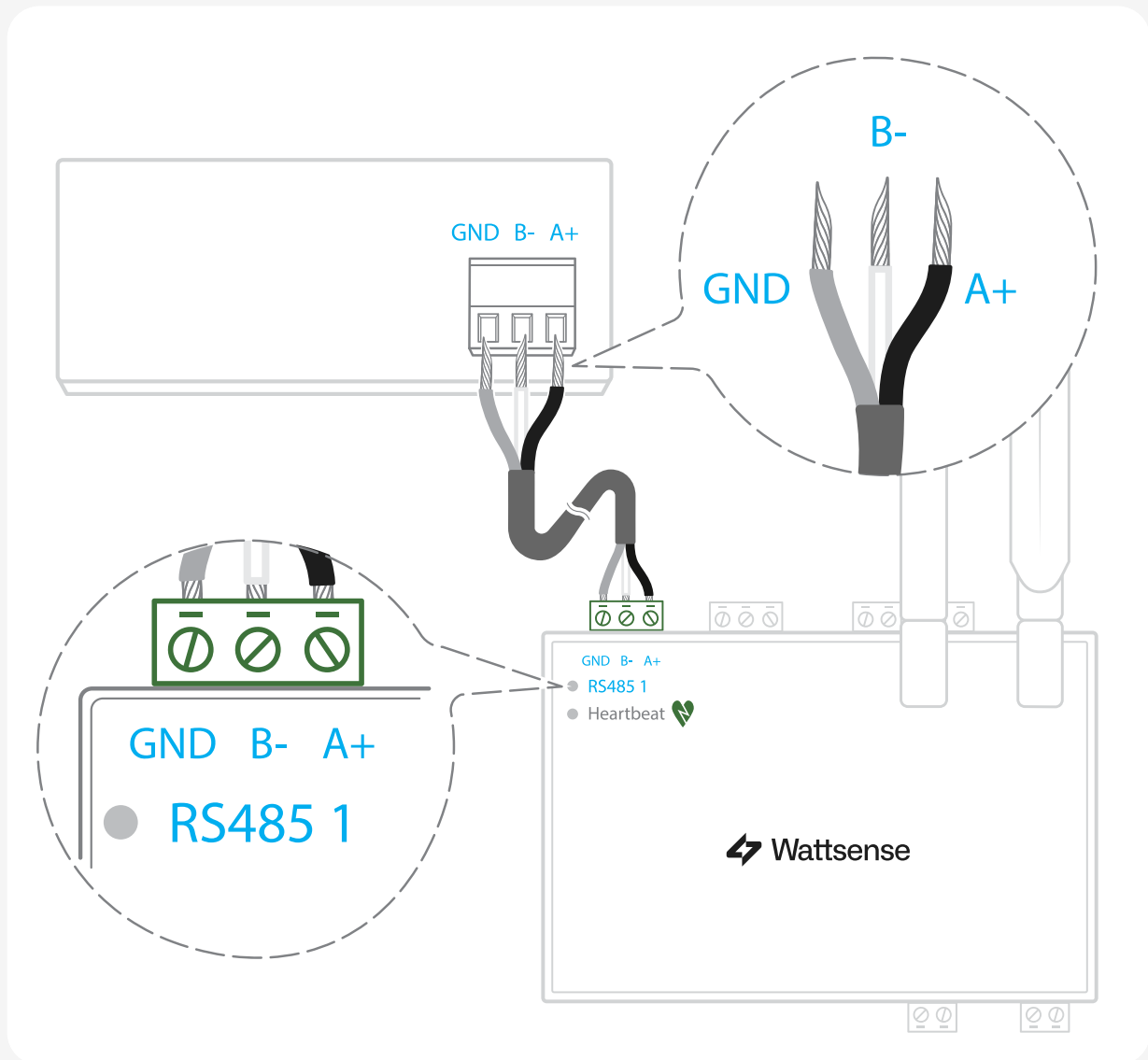

**To configure each one of the equipment:**

- Configure the address of the 1st Modbus slave to 1, the 2nd to 2, the 3rd to 3 and so on.
- Caution: a network must not contain multiple slaves with the same address.
- Write down the network to which the equipment is connected as well as its address, brand, and model of the equipment and any identifying information. This information will be necessary for the installation configuration and to retrieve data.

# ● The equipment communicates in BACnet IP

## To connect one equipment

- Make sure to have an Ethernet cable.
- Connect the cable to the Ethernet port of the box ETH1 or ETH2.

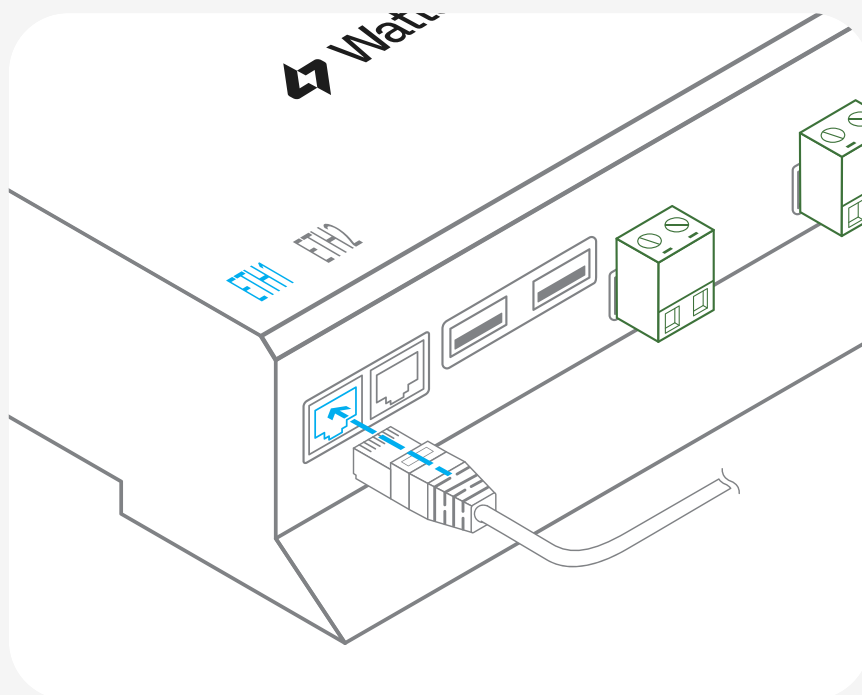

- Connect the other end of the cable to the equipment.

- Verify that the LED ETH1 or ETH2 lights up.

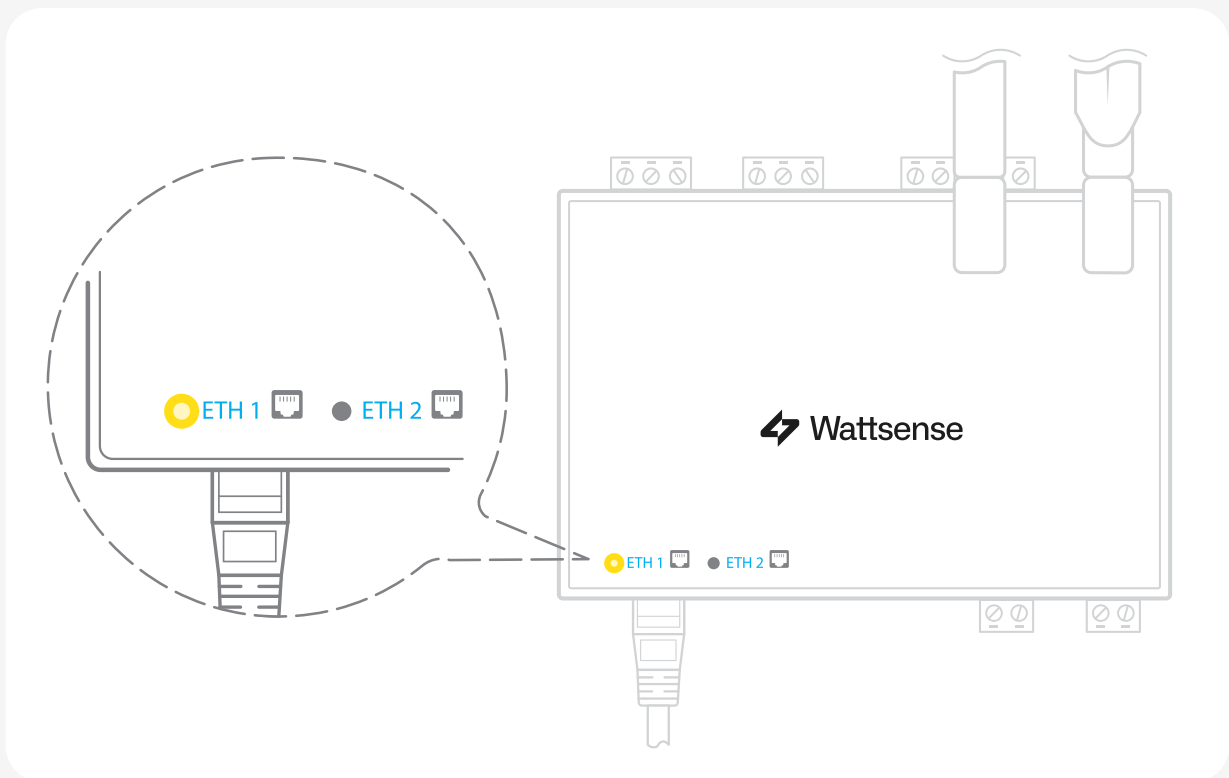

#### To connect two or more devices

- Make sure to have an Ethernet cable for the box.
- Make sure to have as many Ethernet cables as equipment to connect.
- Make sure to have an Ethernet switch.
- Connect the power supply to the switch.

- Connect an Ethernet cable to the Ethernet port ETH1 or ETH2 of the box.

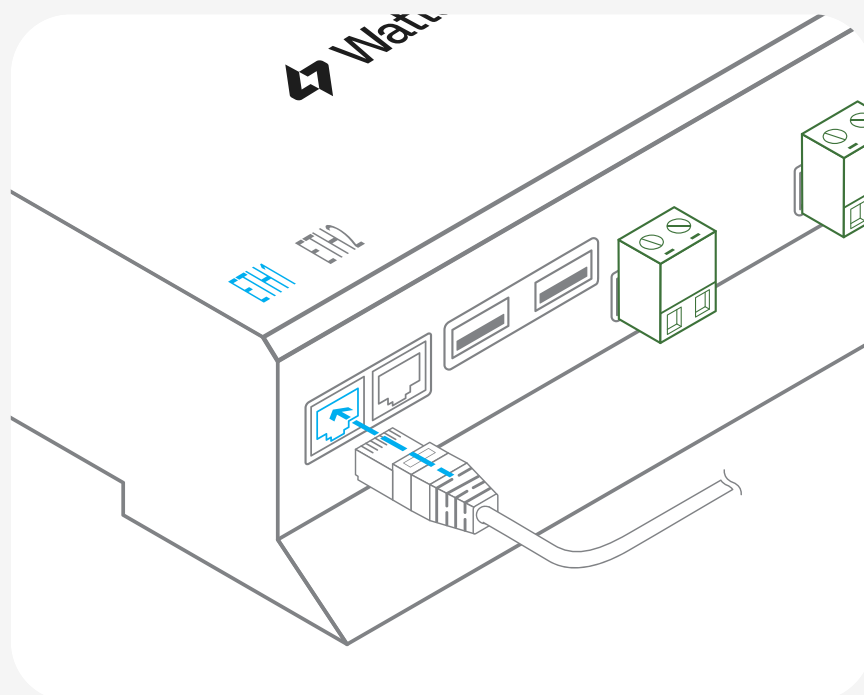

- Connect the other end of this cable to the Ethernet switch.
- Check that the ETH1 or ETH2 LED lights up.

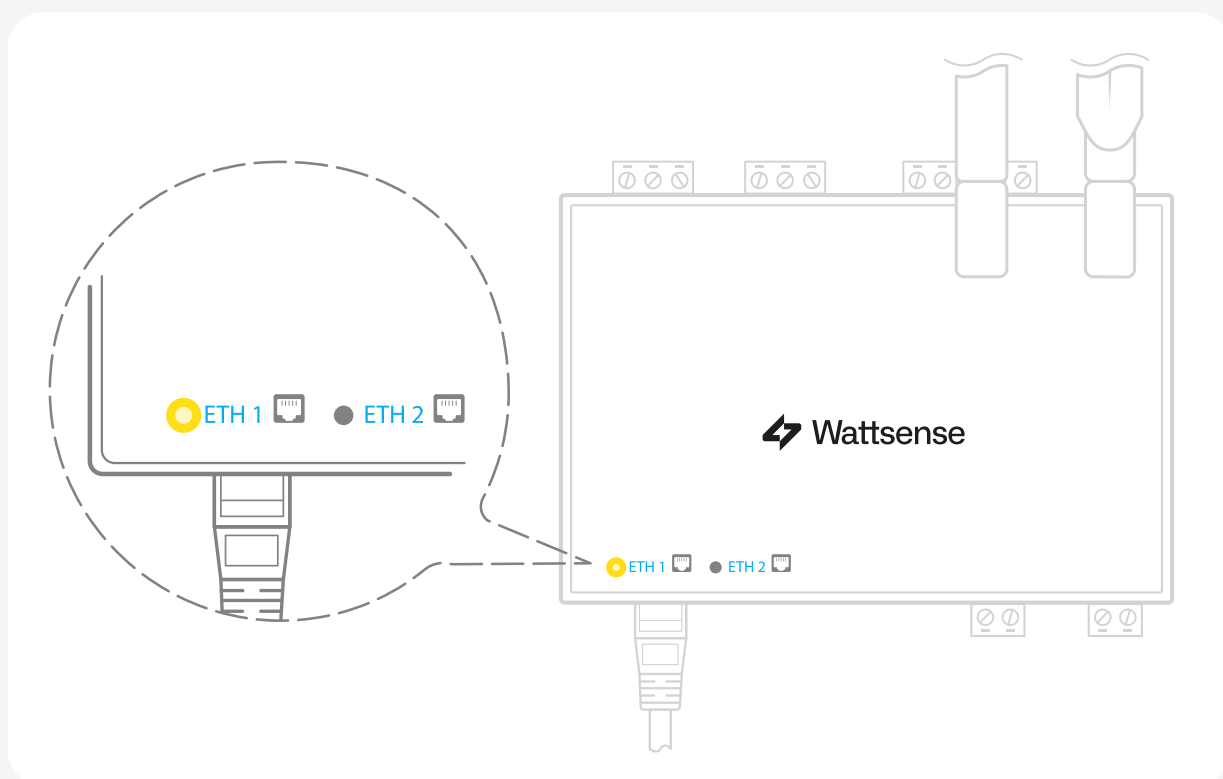

- Connect all equipment to the switch via the Ethernet cables.

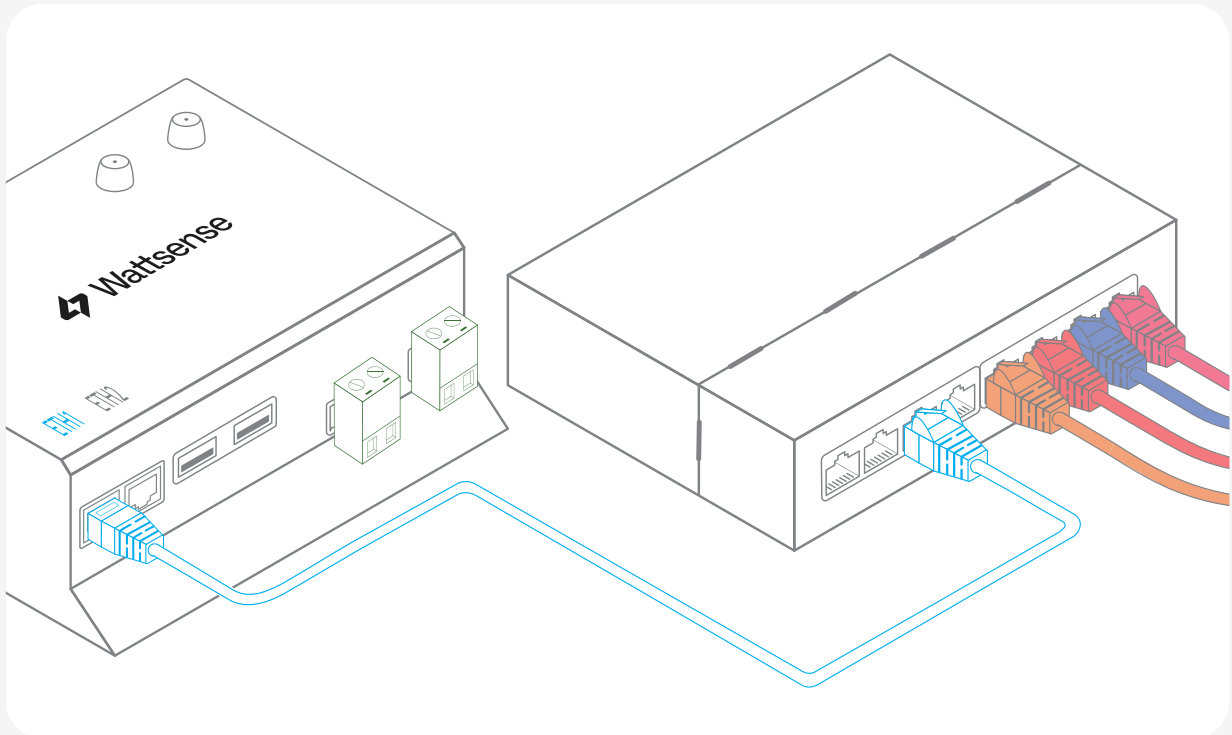

**To configure each of the equipment:**

- From the technical documentation of the equipment, retrieve its IP address and the BACnet port.
- If the equipment does not have an IP address, assign one to it, 192.168.1.1 for the first device, then 192.168.1.2 for the second device, 192.168.1.3 for the third device, and so on.
- Write down the IP address and BACnet port, the brand, and model of the equipment, and any other identifying information. This information will be required to configure the installation and to retrieve data.

# ● The equipment communicates in LON IP-852

To connect one or several types of equipment:

- Make sure to have an Ethernet cable.
- Connect the cable to the Ethernet port of the box ETH1 or ETH2.

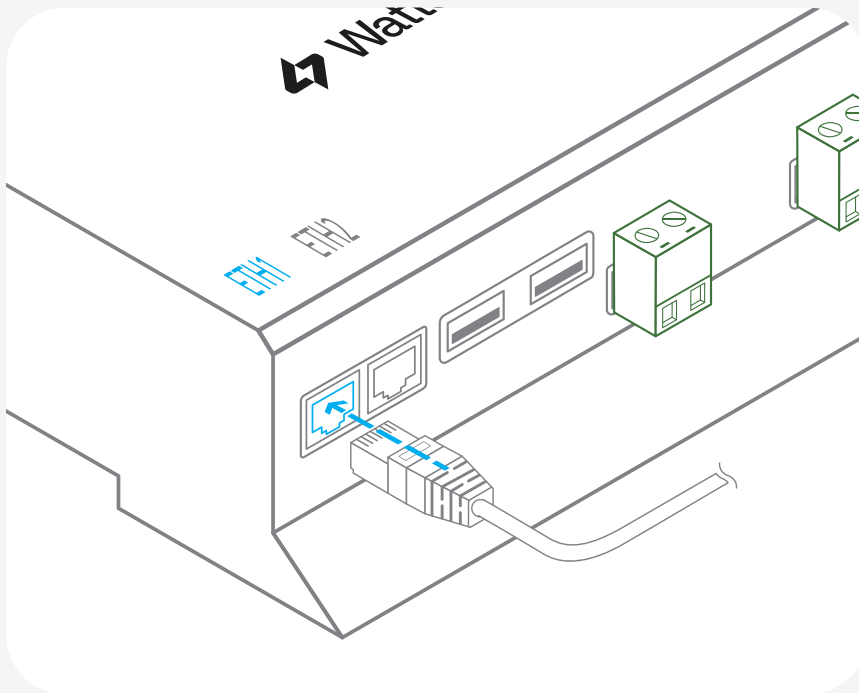

- Connect the other end of the cable to the IP-852 server of the LON network.

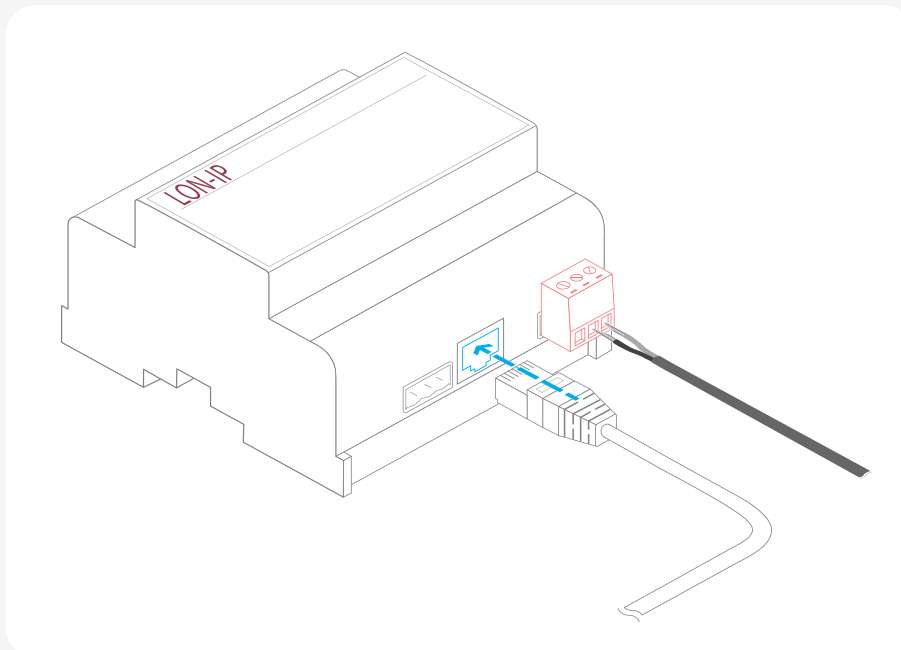

- Verify that the LED ETH1 or ETH2 lights up.

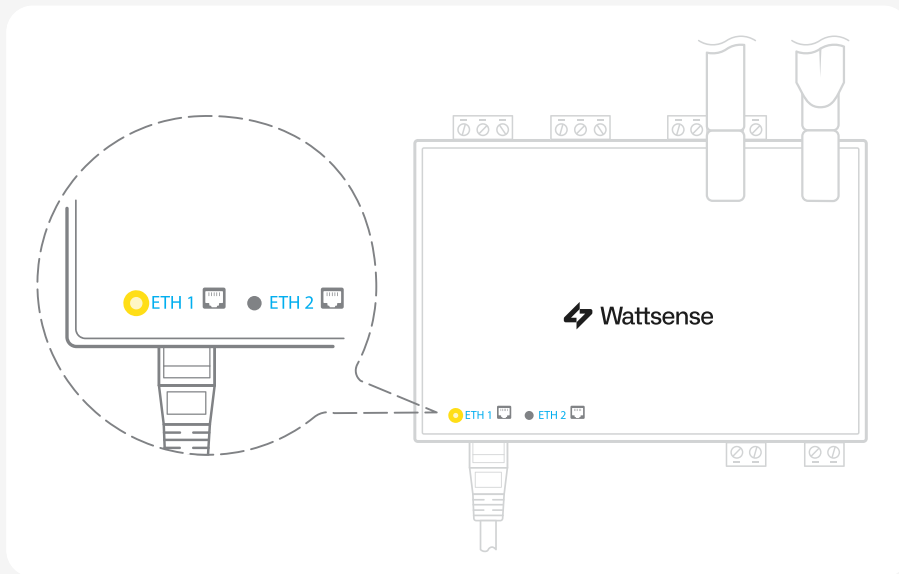

- Register the IP address of the box on the IP-852 server of the LON network.

#### To configure each of the different equipment:

- Write down the Neuron-ID, brand, model of the equipment, and any identifying information. This information will be necessary for the installation configuration and to retrieve data.
- If you have the NL220 software, export the LON database as an archive file or as a NLC file.



# ● The equipment communicates in LPB

## To connect one or several equipment:

- Connect the LPB Bus to the X-Bus port of the box.
- For each device, connect its MB cable to the X-Bus (-) port and its DB cable to the X-Bus (+) port.

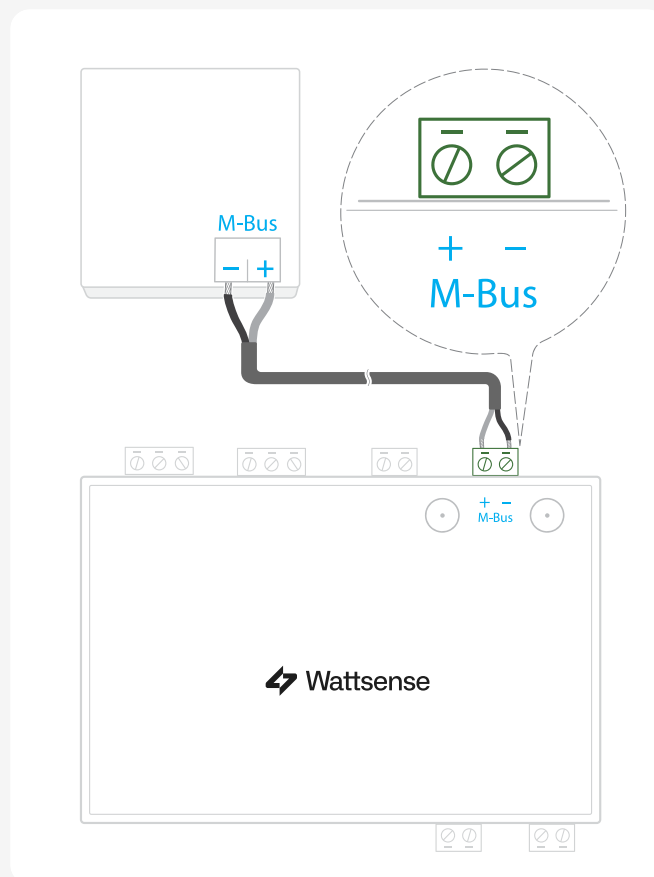

## To configure each one of the equipment:

- Be sure that the LPB bus is not powered during your installation to avoid electrical issues. After your installation is completed remember to power it back.
- For each device, configure a unique device number (from 0 to 16).
- Proceed to make the connection as indicated.
- Designate one and only one equipment as the one that supplies the Bus.

# ● The equipment communicates in KNX

To connect one or several equipment:

- Connect the KNX Bus to the KNX Bus port of the box.
- Each device must connect its (-) signal to the (-) port and its (+) signal to the (+) port.

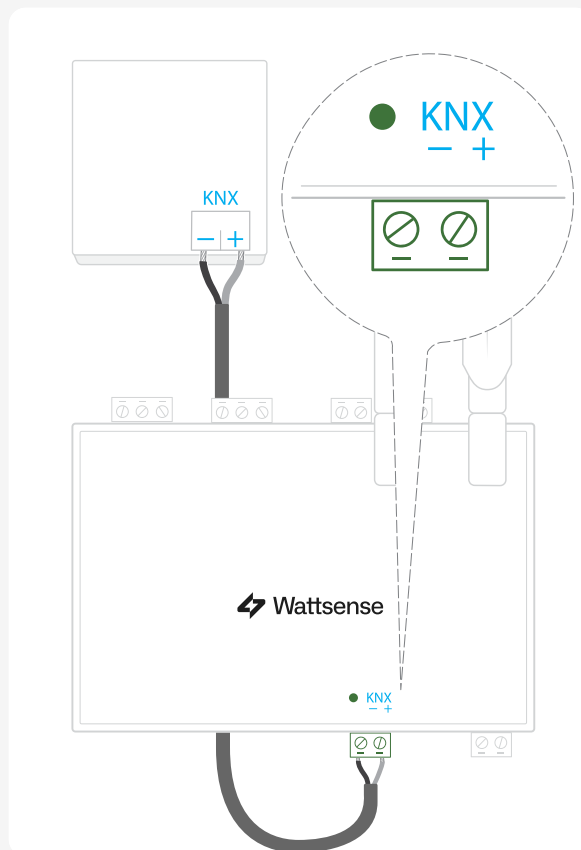

# ● The equipment communicates in M-BUS

## To connect one or several equipments:

The maximum unit load that the device can handle is three devices (3,6mA). If you want to connect more than three M-Bus devices you'll have to use an M-Bus signal repeater.

- Connect the M-Bus device to the M-Bus port.
- Each M-Bus device must connect its (-) signal to the M-Bus (-) port and its (+) signal to the (+) port.

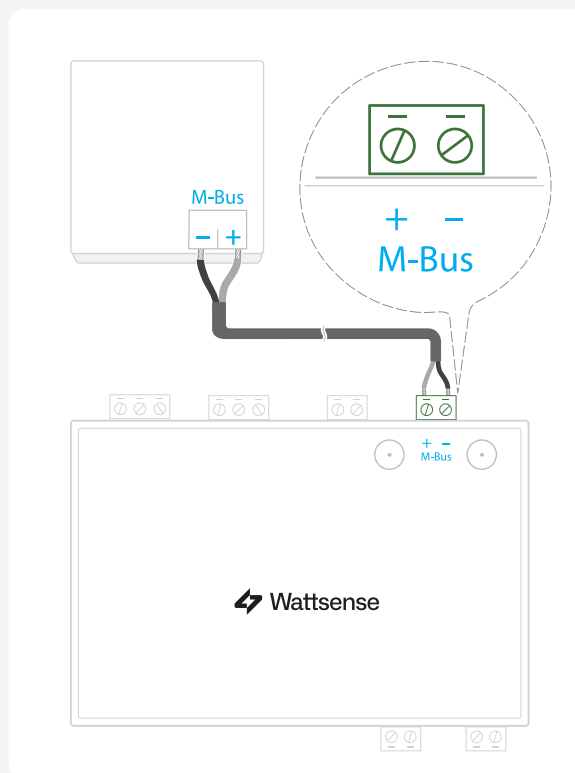

# ● To connect to LoRaWAN sensors

- Install the box in a central location to ensure the reception of all sensors.
- If the quality of the LoRa signal is good: keep the original antenna installed on the device. You can check the quality of the LoRa signal with:
  - A field tester

The Wattsense User Console. Once the device and the LoRa device are paired you can verify the quality of the signal.

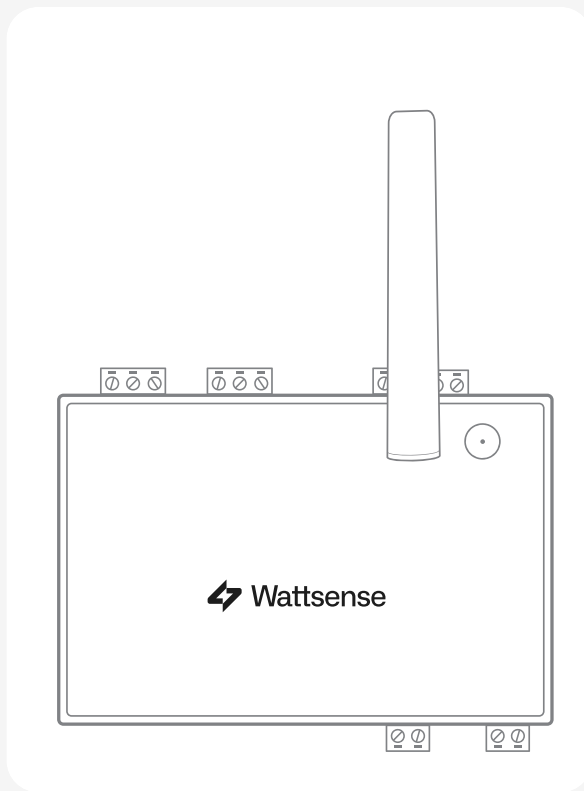

- If the signal quality is insufficient: move the original antenna out of the cabinet; use an RF extension cord with a SMA connector up to 2 meters + 1 adhesive support to hold the antenna.
- If the signal quality is still insufficient: use a High-gain antenna with a maximum of 10 meters of cable; this antenna can for example be used outside or in other floors to obtain the best signal quality

**For each sensor, follow these steps:**

- 1** Add the sensor to the user console (available at <https://console.wattsense.com>) by naming it to be identifiable.
- 2** Save and send the configuration to the box
- 3** Activate the sensor; to do this, use the manufacturer's technical documentation.
- 4** Check on the user console that the sensor is detected.



# Support

The website [support.wattsense.com/portal](https://support.wattsense.com/portal) contains useful information about Wattsense's product (Tutorials, Knowledge base, etc..)

To alert the support team about any issues you are experiencing, please send an email to [support@wattsense.com](mailto:support@wattsense.com) or create a ticket in our support platform.

Please click here: <https://support.wattsense.com/portal/en/newticket>

The support team will get back to you as soon as possible.

