



Table of Contents

- MCF-LW13IO Operating Manual
- 1. Description
- 2. Overview
 - 2.1 Technical data
 - 2.2 Installation
 - 2.3 Power supply
 - 2.4 Configuration
 - 2.5 System leds
 - 2.6 Firmware update
- 3 I/O
 - 3.1 Input
 - 3.2 Output
 - 3.3 Wiring examples
- 4 LoRaWAN® network
 - 4.1 Activation
 - 4.2 Other settings
- 5 Passwords
- 6 Configuration file
 - 6.1 Multi devices configuration
- 7 LoRaWEB Tool
- 8 Payload
- 9 Ordering code
- 10 Declaration of conformity
- 11 FCC compliance for MCF-LW13IO-US
- 12 Contacts

MCF-LW13IO Operating Manual

Important safety information



Read this manual before attempting to install the device! Failure to observe recommendations included in this manual may be dangerous or cause a violation of the law. The manufacturer will not be held responsible for any loss or damage resulting from not following the instructions of this operating manual.

- Do not dismantle or modify in any way.
 - Avoid mechanical stress
 - Do not use any detergent or alcohol to clean the device.
 - Do not mount in horizontal position.

Disposal information for users



Pursuant to and in accordance with Article 14 of the Directive 2012/19/EU of the European Parliament on waste electrical and electronic equipment (WEEE).

The barred symbol of the rubbish bin shown on the equipment indicates that, at the end of its useful life, the product must be collected separately from other waste.

1. Description

The MCF-LW13IO is a LoRaWAN® actuator that allows to switch ON and OFF a 230Vac~, 8A load. It also reads the status of a 230Vac~ input. This device can transmit the status of its input and control the output through the LoRaWAN® network. It can be used for industrial process control and home automation, water treatment, agriculture irrigation and similar applications. Input can be used as pulse counter.



2. Overview

2.1 Technical data

- CPU Cortex M0+

- EEPROM 32KB
- Flash 64KB
- Real time clock
- Encryption AES 128 bit
- Class C LoRaWAN® stack EU868, AS923, AU915, US915
- EU868 version CE certified according to 2014/53/EU – Radio Equipment Directive (RED)
- US915 version FCC compliant
- Transmission band (EU version): 868MHz
- Transmission Power (EU version): 14dBm max
- Power supply 110÷230Vac~ 50/60 Hz
- Power consumption 1W
- 1 opto-isolated input, 230Vac
- 1 relay output with COM, NO, NC contacts, 8A@230Vac~
- NFC for node setup and FW upgrade
- Storage temperature range -20°C ÷ +80°C
- Working temperature range -10°C ÷ +70°C
- Dimension: 58x44x25mm

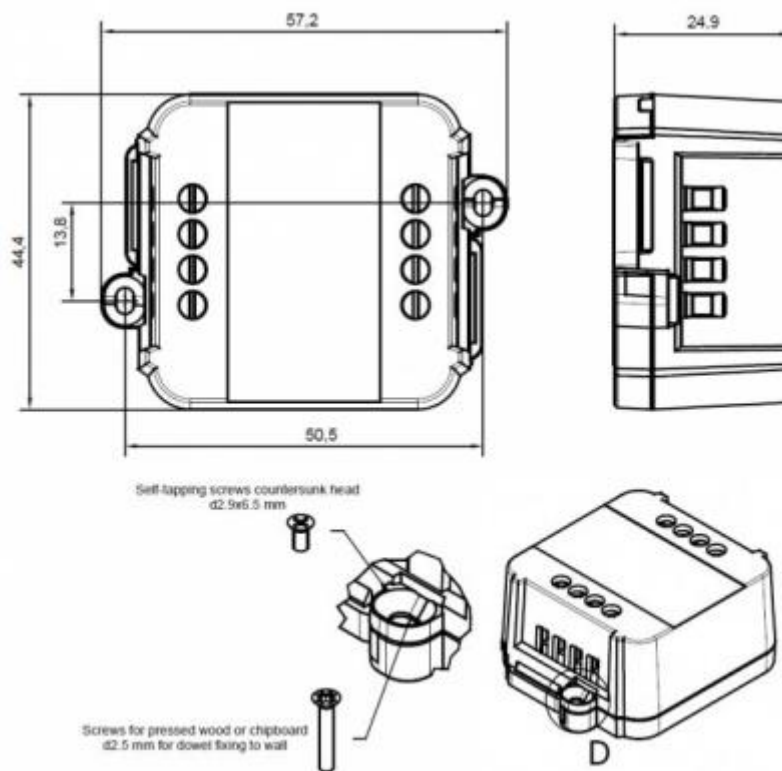

2.2 Installation

The installation has to be done by a qualified electrician.

The device is intended as subassembly (component).

It is responsibility of the assembler of equipment incorporating to ensure that the overall equipment is safe.

The MCF-LW13IO must be mounted in vertical position.

Please refer to following connections:

Name	Description
L LINE	Device power supply: 110÷230Vac~ Live
N LINE	Device power supply: 110÷230Vac~ Neutral
LIN	Digital Input monitor: 110÷230Vac~ Live
NIN	Digital Input monitor: 110÷230Vac~ Neutral
C	Terminal for Common contact
NC	Terminal for Normally Close contact
NO	Terminal for Normally Open contact



Caution: NIN and NLINE are internally connected.

The device must be placed where the LoRaWAN® signal coverage is good (SF = 7 optimal, SF = 12 weak).

2.3 Power supply

Connect the power supply to pins L LINE and N LINE. Valid range is 100Vac~ to 240Vac~ 50/60Hz.

2.4 Configuration

To deploy the sensor, download the latest [LoRa Tool](#) Android App to setup LoRaWAN® credentials and other preferences :



110/230Vac

Move the NFC antenna of the mobile (the exact position varies depending on the model of the smartphone) to the sensor antenna, in the area shown in the figure:

N









To use the NFC interface, the device must be powered through terminals L LINE and N LINE. The power status is visible on the red/green led.

Always validate your settings by reading the NFC data after the sensor has restarted.

Configuration can be done only via NFC. No USB port available.

2.5 System leds

LoRaWAN® not configured		Slow flashing
Joining		Quick flashing
Sending		Quick flashing
Receiving		Quick flashing
Steady state		Fixed
Data error		Flashing 2 seconds
Connection error		Flashing 1 second

2.6 Firmware update

Download the latest firmwares available on the smartphone with LoRaTool app:

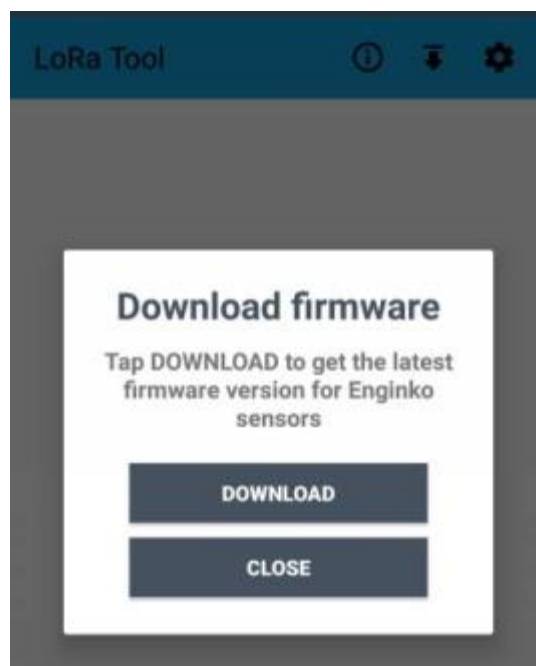

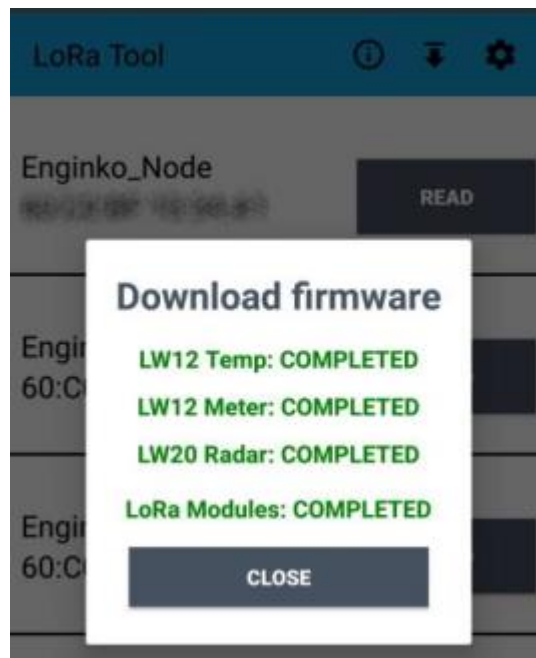

Update the sensor with LoRaTool:



During the update, do not move the smartphone until the end message.

3 I/O

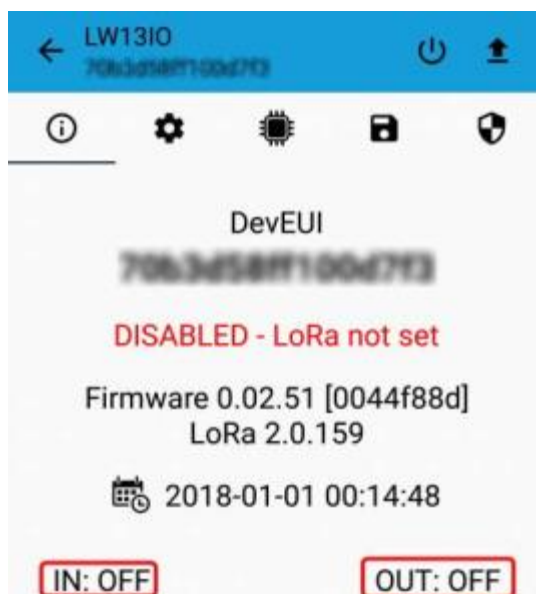

As default, the device sends a message every time an input or an output changes.

A downlink with new output status forces the device to send back an uplink with the new status. If the output status is the same of current one, the sensor will not send back any message.

Downlink examples (hex):

```

turn ON the output:    0400 0100 0000 0000 0000
turn off the output:   0400 0000 0000 0100 0000
receive the current status: 0400 0000 0000 0000 0000
  
```

Is possible to set a period (in minutes) to receive a recurrent periodic message with the I/O status.

3.1 Input

Off voltage 0÷2Vac 50/60Hz
 On Voltage >8Vac 50/60Hz

Maximum input voltage	250Vac 50/60Hz
Input current	3mA _{typ}
Max frequency (as counter)	2 Hz
Optoinsulation	NONE

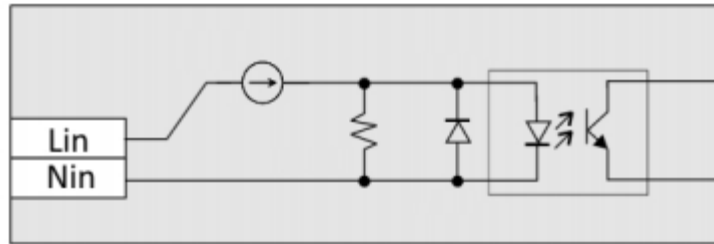

Caution: NIN and NLINE are internally connected.
Input can be used as pulse counters (see settings chapter).

3.2 Output

Contact mode	SPDT
Max. power commutable	2000VA
Maximum switching voltage	
Max. current	8A

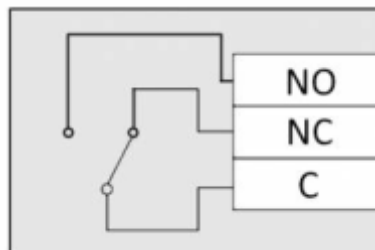

The output has pulse capability (minimum pulse duration is 100ms, maximum around 100 minutes), so, instead to send two different commands (one to turn on and one to turn off the output), is possible to send a duration command.
As application example, to safely turn on an output, send a ON-pulse command for a defined time (for example, for the maximum allowed interval), and before the expiring time, another ON-pulse command (making a kind of watchdog) if the output still needs to be ON, or a simply OFF command if you want to turn it off.

3.2.1 Time schedule

It is possible to program the device with a weekly calendar, based on day of the week and time, to turn ON and OFF the output at a defined time:

#	Label	Week							Feedback	Hours	Outputs									
		Sunday	Monday	Tuesday	Wednesday	Thursday	Friday	Saturday			1	2	3	4	5	6	7	8		
1	Mon-Fri sign ON	●	●	●	●	●	●	●	Yes	08:00	●	●	●	●	●	●	●	●	●	●
2	Sat-Sun sign ON	●	●	●	●	●	●	●	Yes	08:00	●	●	●	●	●	●	●	●	●	●
3	Sat-Sun sign OFF	●	●	●	●	●	●	●	Yes	12:00	●	●	●	●	●	●	●	●	●	●
4	Mon-Fri sign OFF	●	●	●	●	●	●	●	Yes	20:00	●	●	●	●	●	●	●	●	●	●

and generate an XLS file that can be downloaded by downlinks:

Label	Hour	Minute	Sun	Mon	Tue	Wed	Thu	Fri	Sat	MC	Payload
Mon-Fri sign ON	8	0	0	1	1	1	1	1	0	0	04000100000000000000
Sat-Sun sign ON	8	30	1	0	0	0	0	0	1	0	04000100000000000000
Sat-Sun sign OFF	12	30	1	0	0	0	0	0	1	0	04000000000001000000
Mon-Fri sign OFF	20	0	0	1	1	1	1	1	0	0	04000000000001000000

3.3 Wiring examples

Load connected to the same supply of the sensor, connected to the relay output (normally open contact):



Load connected to an auxiliary power supply (AC or DC), connected to the relay output (normally open contact), and a switch connected the digital input :

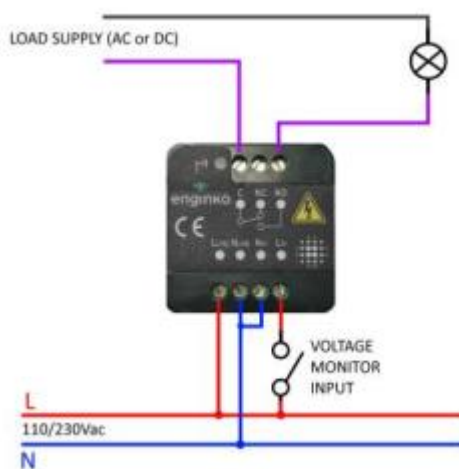

4 LoRaWAN® network

The sensor is compliant with LoRaWAN® specification 1.0.2, regional 1.0.2b.



4.1 Activation

The device supports the following activations on a LoRaWAN® network:

1. **NONE**: sensor not activated
2. **OTAA**: the JoinEUI and the AppKey not setted, must be written to the device;
3. **OTAA MCF88**: Over the air activation, fixed keys: JoinEUI = 904e915000000003, AppKey on request;
4. **OTAA ENGINKO**: Over the air activation, fixed keys: JoinEUI = 904e915000000003, AppKey on request;
5. **ABP**: requires writing to the device of NwkSkey, AppSkey, DevAddr.



The device exits factory activated with **NONE** mode. On request devices can be shipped already activated.

Note: in **OTAA** AppKey is write only, in reading the field will always be empty, even if set.

4.2 Other settings

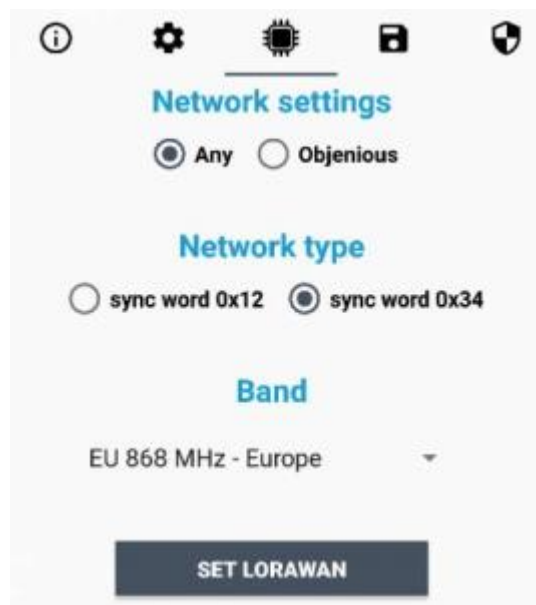

Network settings:

please keep "Any" settings. Change it only if Objenious network is used (default_ any).

Network type:

LoRa syncword can be setted as "private"(0x12) instead "public" (0x34), but the NS must be setted accordingly(default: public).

Band:

select the right LoRaWAN® band settings accodingly to country requirements.

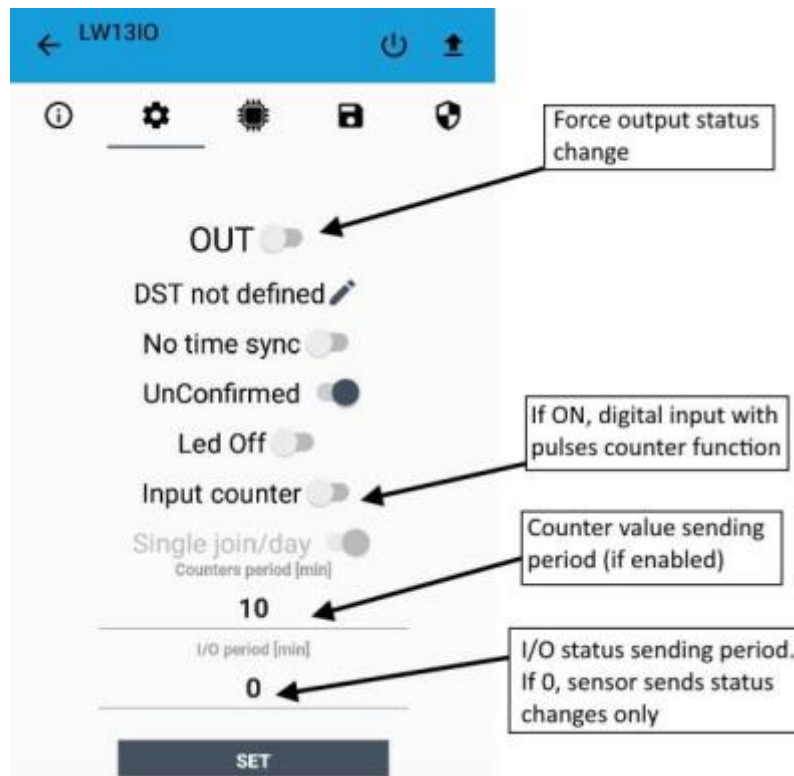

OUT:
set to force a change of the output (default: off).

DST:
set to change DST (default: none).

No time sync:
set to disable time synchronization request (default: enabled).



Normally sensor asks for a time sync at every power on (uplink starting with 01) or, if enabled, once a week.

Please check chapter 2.1. [DATA FRAME FORMAT](#).

UnConfirmed:
set for unconfirmed uplinks (default: confirmed uplink).

Led Off:
set to disable the system leds (default: enabled).

Input counter:
set to enable the pulses counter function (default: disabled).

Single join/day:
set for to allow only one join per day (default: multiple join allowed).

Counters period [min]:
if counter enabled, this is the interval (in minutes) between one measure and the next one. The sensor sends one measures for every transmission. Value can be between 1 and 255 minutes (default: 0 minutes). Period interval can be set with App or with downlink command.

I/O period [min]:
if different from 0, this is the interval (in minutes) between one I/O messages status and the next one. Value can be between 1 and 255 minutes (default: 0 minutes - disabled). Period interval can be set with App or with downlink command.

5 Passwords

The device can be protected by passwords, to avoid unauthorized persons to read data or modify parameters.
As default passwords are equal to 0.

Allowed values range from 0 to 999999999 (only numbers).

To change the passwords, set the new values with the LoRa Tool App:

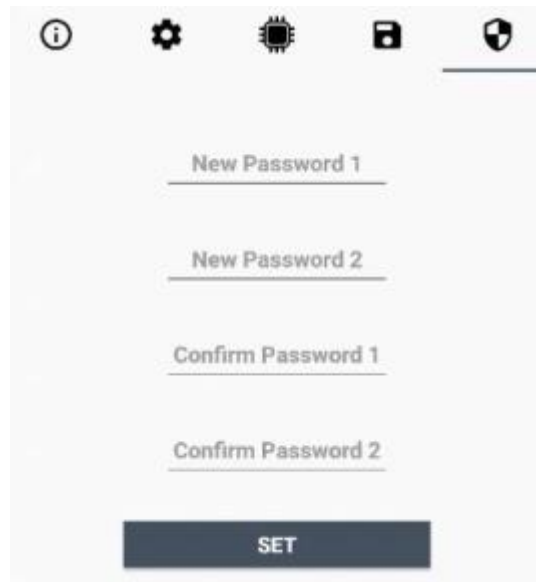

A screenshot of a mobile application's password setup screen. At the top, there is a navigation bar with five icons: an information icon, a gear icon, a microchip icon, a document icon, and a shield icon. Below the navigation bar, there are four text input fields labeled "New Password 1", "New Password 2", "Confirm Password 1", and "Confirm Password 2". At the bottom of the screen, there is a dark grey button labeled "SET".

Once the passwords are setted, to gain access from LoRa Tool to the sensor, open the App:

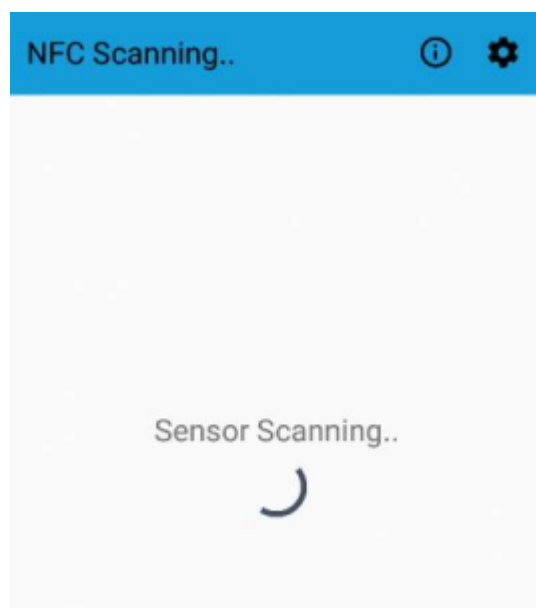

and set the right values before reading from the device:



A screenshot of a mobile application's "Settings" screen. The title bar is blue and contains a back arrow icon and the text "Settings". Below the title bar, there is a red-bordered box containing two password input fields labeled "Password1" and "Password2", each with a toggle icon to its right. Below these fields is a dark grey button labeled "SET". Below the red-bordered box, there are four sections of settings, each with a toggle switch to its right: "General configuration", "Specific configuration", "Verify passwords after reading", and "Set passwords after reading". Each of these sections has a "SET" button to its right.

To bring back the sensor to factory default an reset the password, a reset code must be requested to enginko (please provide the DevEUI of the sensor when you ask for that code).

6 Configuration file

With LoRa Tool App is possible to configure the device using an XML file, instead to manually adjust the parameters (for details about the file format please ask to enginko). This is very useful especially in case of multiple devices configuration.

With "Save" button an XML file with the actual configuration of the sensor will be generated. This is useful to store or clone the configuration, or to send it to enginko's support if needed.

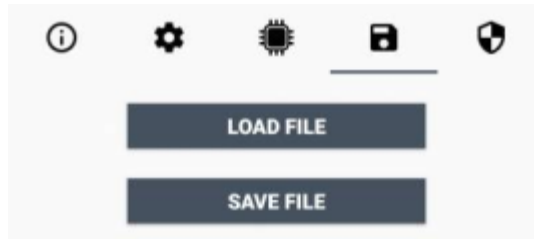

6.1 Multi devices configuration

With LoRa Tool App is possible to configure many devices in an easy way.

For multi-configuration is needed at least one XML file with the parameters to set.

Settings on this file will be applied to all the sensors.

With an additional XLS file is possible to load different LoRa configuration parameters (Activation Type, AppKey, AppEUI, NetKey, DevAddress, Band, Private option) for each sensor, based on DevEUI.

When the sensor is approached, if one parameter is different from files, the APP will ask you if you want to overwrite.

XLS is prevailing on the XML, so if both files are enabled, if the DevEUI of the device matches one of the DevEUIs in the XLS file, LoRa parameters will be setted from this one.

These configuration can be done in the in the Settings:

- Enable or disable the use of the general configuration by file;
- Enable or disable the use of the specific configuration by file;
- Verify the passwords;
- Writing the passwords.

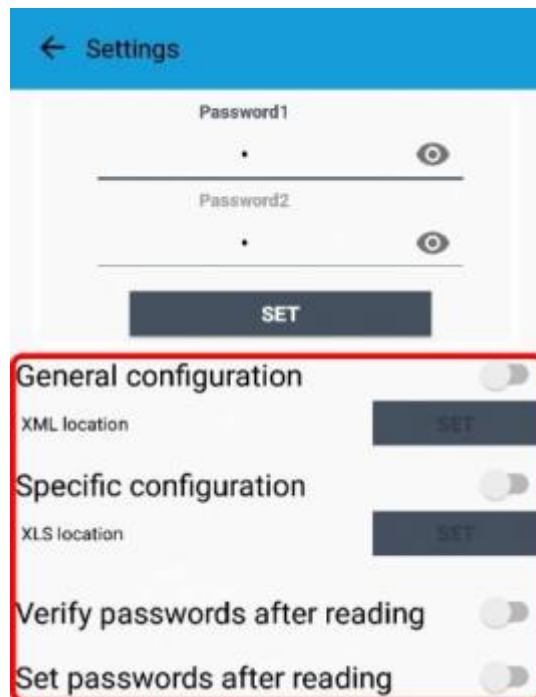

For details on files format please ask to enginko.

7 LoRaWEB Tool

enginko provides, upon free registration, **LoRaWEB** online tool, where for each sensor it is possible to find documentation, javascript examples for parsing, downlink generator and uplink decoder:

[LoRaWEB Tool](https://iot.mcf88.cloud/LoRaWeb) (iot.mcf88.cloud/LoRaWeb)

.....

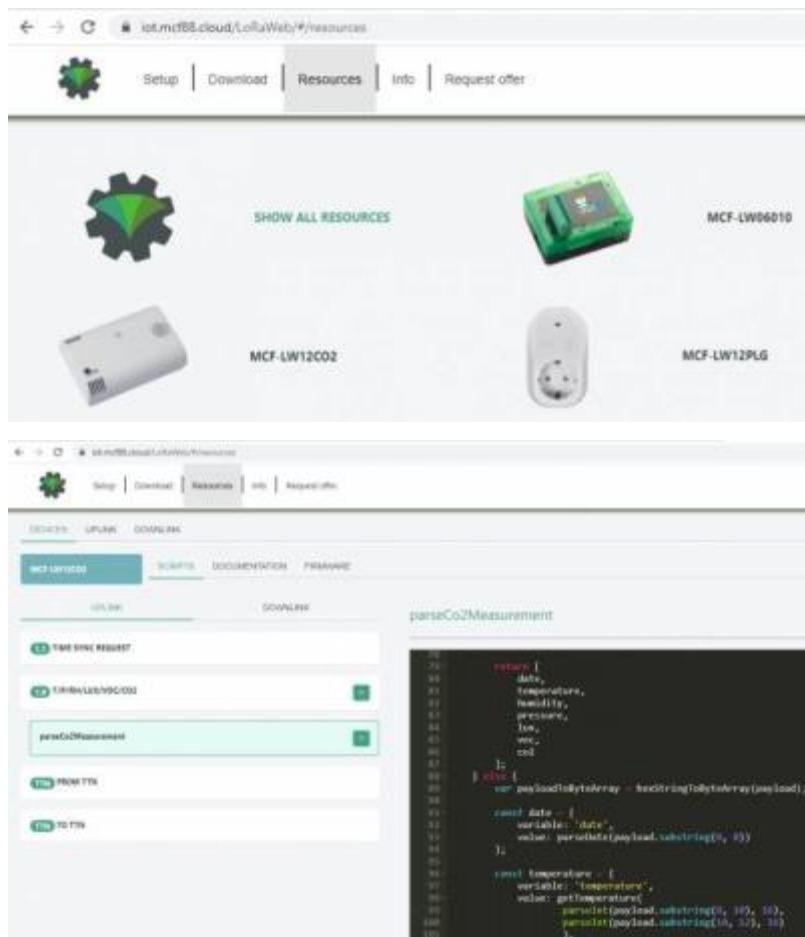

8 Payload

For payload descriptions, uplinks and downlinks format and available commands please refer to this document:

DATA FRAME FORMAT

9 Ordering code

Code	Description
MCF-LW13IO	enginko LoRaWAN® wireless actuator EU863-870
MCF-LW13IO-AS	enginko LoRaWAN® wireless actuator AS920-925
MCF-LW13IO-US	enginko LoRaWAN® wireless actuator US902-928
MCF-LW13IO-AU	enginko LoRaWAN® wireless actuator AU915-928

10 Declaration of conformity

Hereby, enginko Srl declares that MCF-LW13IO complies with the essential requirements and other relevant provisions of Directive 2014/53/EU.

11 FCC compliance for MCF-LW13IO-US

This device complies with part 15 of the FCC Rules. Operation is subject to the following two conditions: (1) This device may not cause harmful interference, and (2) this device must accept any interference received, including interference that may cause undesired operation.

This equipment has been tested and found to comply with the limits for a Class B digital device, pursuant to part 15 of the FCC Rules. These limits are designed to provide reasonable protection against harmful interference in a residential installation. This equipment generates, uses and can radiate radio frequency energy and, if not installed and used in accordance with the instructions, may cause harmful interference to radio communications. However, there is no guarantee that interference will not occur in a particular installation. If this equipment does cause harmful interference to radio or television reception, which can be determined by turning the equipment off and on, the user is encouraged to try to correct the interference by one or more of the following measures:

- Reorient or relocate the receiving antenna.
- Increase the separation between the equipment and receiver.
- Connect the equipment into an outlet on a circuit different from that to which the receiver is connected.
- Consult the dealer or an experienced radio/TV technician for help.

Any changes or modifications not expressly approved by the party responsible for compliance could void the user's authority to operate this equipment.

Contains FCC ID: 2AWAL409810

12 Contacts

enginko Srl

Via Roma 3 I-28060

Sozzago(NO)

T: +39 0321 15 93 088

E: info@enginko.com

PEC: enginkosrl@legalmail.it

W: enginko.com

rev. 1